

Class A & C Owner's Manual



TABLE OF CONTENTS

FOUR WINDS LIMITED WARRANTY	4
ACKNOWLEDGEMENT OF RECEIPT OF WARRANTY	7
GENERAL INFORMATION.....	10
DISCLAIMER	11
SYMBOLS	11
MANUFACTURER'S WARRANTIES.....	12
VENDOR CONTACT INFORMATION	12
MOTOR HOME LOAD LIMITS.....	13
VEHICLE WEIGHING PROCEDURES	14
IDENTIFICATION AND SAFETY.....	16
REPORTING SAFETY DEFECTS	16
LAWS OF THE ROAD.....	16
MOTOR HOME SERIAL NUMBER DECAL AND DATA PLATES	17
SAFETY REGULATIONS FOR PROPANE GAS SYSTEMS AND APPLIANCES	17
FIRE SAFETY.....	18
FIRE EXTINGUISHER	19
CARBON MONOXIDE AND SMOKE DETECTORS.....	19
PROPANE GAS DETECTOR.....	21
CHEMICAL SENSITIVITY	23
SEAT BELTS	23
EGRESS WINDOW.....	25
TRAILER TOWING.....	25
CHASSIS.....	26
EMERGENCY STOPPING.....	26
ENGINE AND DRIVE TRAIN	26
FUELING THE MOTOR HOME.....	27
TRAVEL PREPARATION.....	28
CONTROLS AND OPERATIONS.....	30
DASH CONTROLS - GAS	30
DASH CONTROLS AND INSTRUMENT PANELS - DIESEL	31
SHIFTER PANEL SWITCHES.....	33
DASH PANEL SWITCHES	34
PASSENGER ARMREST SWITCHES	35
STEERING WHEEL ADJUSTMENT.....	36
TURN SIGNAL/LANE CHANGE/HIGH-LOW BEAM/HAZARDS LEVER.....	36
SMART STEERING WHEEL.....	37
SPOTLIGHT	38
REAR VISION SYSTEM.....	38
DASH RADIO	39
ECLIPSE GPS NAVIGATION SYSTEM OPTION DIESEL.....	41
KEYPAD KEYLESS ENTRY SYSTEM.....	42
AUTOMATIC HYDRAULIC POWER LEVELERS.....	43
SLIDE OUTS	46
WINDOWS.....	50
DOORS, DRAWERS AND STORAGE COMPARTMENTS.....	50
SLEEP NUMBER BED	50
ELEVATED BEDS AND ELECTRIC BED LIFT SYSTEMS.....	51
FURNITURE.....	52

ENTRY DOOR	55
ENTRY STEP	55
STORAGE COMPARTMENTS	56
REAR LADDER/ROOF ACCESS	56
AWNINGS	56
GARAGE AREA (AVAILABLE ON SELECT MODELS)	58
HEATING AND AIR CONDITIONING	59
DASH PANEL HEATER AND AIR CONDITIONER	59
ROOF MOUNTED AIR CONDITIONER	60
FURNACE	61
THERMOSTATS	61
CEILING VENTS	61
ELECTRICAL SYSTEMS	63
SHORE CORD	63
BATTERIES	64
POWER CONVERTER	67
POWER INVERTER - DIESEL	67
GROUND FAULT CIRCUIT INTERRUPTER	68
12 VOLT SYSTEM FUSES - GAS	69
CIRCUIT BREAKERS	69
CLASS A AND CLASS C - GAS SYSTEM PANELS	70
12 VOLT SYSTEM FUSES - DIESEL	71
DASH FUSES	72
CHASSIS ALTERNATOR	72
GENERATOR	73
WATER SYSTEMS	74
FRESH WATER SYSTEM	74
MONITOR PANEL	77
WASTE WATER SYSTEM	77
TOILETS	80
WATER SYSTEM WINTERIZATION	81
WATER SYSTEM MAINTENANCE	82
SYSTEMS COMPARTMENT - DIESEL	83
PROPANE GAS SYSTEMS	84
PROPANE GAS TANK	84
PROPANE GAS HOSES PIPES TUBES AND FITTINGS	86
PROPANE GAS SAFETY PRECAUTIONS	87

CARE AND MAINTENANCE	88
FIBERGLASS SIDING.....	88
EXTERIOR PAINT (OPTIONAL)	89
SEALS AND ADHESIVES	89
FRAME	90
WHEELS.....	90
ROOF	90
EXTRUSIONS AND ALUMINUM SURFACES	90
WINDOWS AND DOORS.....	91
PROPANE GAS SYSTEM.....	91
DRAINAGE SYSTEM	91
TV ANTENNA.....	92
EXTERIOR LIGHTS	92
SINKS AND COUNTERTOPS.....	93
APPLIANCES	93
PRE-FINISHED PANELS AND WOOD SURFACES.....	94
WATER SYSTEM	94
ELECTRICAL SYSTEM.....	94
ROOF VENTS	94
ABS PLASTIC	94
WINTER PRECAUTIONS	95
STORAGE PREPARATION.....	96
MOLD	96
PERIODIC MAINTENANCE CHART.....	100

FOUR WINDS LIMITED WARRANTY

WHAT THE PERIOD OF COVERAGE IS:

This Limited Warranty provided by Four Winds® (“Warrantor”) covers those components, assemblies and systems of your new motor home not excluded under the section “What is Not Covered”, when sold by an authorized dealer. The duration of the limited warranty ends twelve (12) months after you first take delivery of the motor home from an authorized dealership or after the odometer reaches 15,000 miles, whichever occurs first. However, this Limited Warranty provided by Warrantor covers the steel or aluminum frame structure, only, of the sidewalls (excluding slide outs), roof, and rear and front walls for twenty-four (24) months from the original retail purchase date or the first 24,000 miles of use, whichever occurs first.

If the motor home is not of the current or prior model year when you take delivery of the motor home OR you register your new motor home in a business name or use your motor home for any rental, commercial or business purposes whatsoever, the duration of the limited warranty ends ninety (90) days after you first take delivery of the motor home or after the odometer reaches 5,000 miles, whichever occurs first. The duration of the Limited Warranty covering the steel or aluminum frame structure, only, of the sidewalls (excluding slide outs), roof, and rear and front walls ends twelve (12) months after you first take delivery of the motor home or after the odometer reaches 15,000 miles, whichever occurs first. A conclusive presumption that your motor home has been used for commercial and/or business purposes arises if you have filed a federal or state tax form claiming any business tax benefit related to your ownership of the motor home.

LIMITATIONS AND DISCLAIMER OF IMPLIED WARRANTIES

IMPLIED WARRANTIES, IF ANY, ARISING BY WAY OF STATE LAW, INCLUDING ANY IMPLIED WARRANTY OF MERCHANTABILITY AND ANY IMPLIED WARRANTY OF FITNESS FOR A PARTICULAR PURPOSE, ARE LIMITED IN DURATION TO THE TERM OF THIS LIMITED WARRANTY AND ARE LIMITED IN SCOPE OF COVERAGE TO THOSE PORTIONS OF THE MOTOR HOME COVERED BY THIS LIMITED WARRANTY. WARRANTOR DISCLAIMS ALL IMPLIED AND EXPRESS WARRANTIES, INCLUDING THE IMPLIED WARRANTY OF MERCHANTABILITY AND THE IMPLIED WARRANTY OF FITNESS FOR A PARTICULAR PURPOSE, ON COMPONENTS AND APPLIANCES EXCLUDED FROM COVERAGE AS SET FORTH BELOW. There is no warranty of any nature made by Warrantor beyond that contained in this Limited Warranty. No person has authority to enlarge, amend or modify this Limited Warranty. The dealer is not the Warrantor’s agent but is an independent entity. Warrantor is not responsible for any undertaking, representation or warranty made by any dealer or other person beyond those expressly set forth in this Limited Warranty. Some states do not allow limitations on how long an implied warranty lasts, so the above limitation may not apply to you.

WHAT THE WARRANTY COVERS

Warrantor’s Limited Warranty covers only defects in the workmanship performed and/or materials used to assemble those portions of your motor home covered by the limited warranty. See also the section “What the Warranty Does Not Cover” set out below. “Defect” means the failure of the workmanship performed and/or materials used to conform to Warrantor’s design and manufacturing specification and tolerances.

WHAT WE WILL DO TO CORRECT PROBLEMS

Warrantor’s sole and exclusive obligation is to repair and/or replace, at its option, any covered defect if: (1) you notify Warrantor or one of its authorized servicing dealers of the defect, which is discovered within the warranty coverage period, within ten (10) days of discovering the defect; and (2) you deliver your Motor home to Warrantor or Warrantor’s authorized servicing dealer at your cost and expense. It is reasonable to expect some service items to occur during the warranty period. The performance of warranty repairs shall not extend the original warranty coverage period. Further, any performance of repairs after the warranty coverage period has expired or any performance of repairs to component parts and appliances that are excluded from coverage shall be considered “good will” repairs, which shall not alter the express terms of this limited warranty. If the repair or replacement remedy fails to successfully cure a defect after Warrantor received a reasonable opportunity to cure the defect(s), your sole and exclusive remedy shall be limited to Warrantor paying you the cost of having an independent third party perform repairs to the defect(s). Warrantor may use new and/or remanufactured parts and/or components of substantially equal quality to complete any repair. Defects and/or damage to interior and exterior surfaces, trim, upholstery and other appearance items may occur at the factory during manufacture, during delivery of the motor home to the selling dealer or on the selling dealer’s lot. Normally, any such defect or damage is detected and corrected at the factory or by the selling dealer during the inspection process performed by the Warrantor and the selling dealer. If, however, you discover any such defect or damage when you take delivery of the motor home, you must notify your dealer or Warrantor within ten days of the date of purchase to have repairs performed to the defect at no cost to you as provided by this Limited Warranty. If two unsuccessful repair attempts have been made to correct any covered defect that you believe substantially impairs the value, use or safety of your motor home, or repairs to any covered defect(s), which you believe substantially impairs the value, use or safety of your motor home, have taken 20 or more days to complete, you must, to the extent permitted by law, notify Warrantor directly in writing of the failure to successfully repair the defect(s) so that Warrantor can become directly involved in exercising a final repair attempt for the purpose of performing a successful repair to the identified defect(s).

Minor adjustments, such as adjustments to the interior or exterior doors, drawers, latches by way of example and not by limitation will be performed by your selling dealer during the first ninety (90) days of warranty coverage. Thereafter, such adjustments are the owner’s exclusive responsibility as normal maintenance.

HOW TO GET SERVICE

The "Acknowledgement of Receipt of Warranty/Product Information" form must be returned to Warrantor promptly upon purchase to assure proper part replacement and repair of your motor home. Failure to return the "Acknowledgement of Receipt of Warranty/Product Information" form will not affect your rights under the Limited Warranty so long as you can furnish proof of purchase. For warranty service simply contact one of Warrantor's authorized service centers for an appointment, then deliver your motor home (at your expense) to the service center.

If you need assistance in locating an authorized warranty service facility, contact Warrantor's Warranty Department.

The toll free phone number is:

877-TLK-2-TMS
or 877-855-2867

The mailing address is:

P.O. Box 1486
Elkhart, Indiana 46515-1486

WHAT THE WARRANTY DOES NOT COVER

This Limited Warranty does not cover: any motor home sold or registered outside of the United States or Canada; items which are added or changed after the motor home leaves Warrantor's possession; items that are working as designed but with which you are unhappy with because of the design; normal wear and usage, such as fading or discoloration of fabrics, or the effects of moisture inside the motor home; defacing, scratching, dents and chips on any surface or fabric of the motor home, not caused by Warrantor; owner maintenance, including by way of example replacement of wiper blades, bulbs, filters, wheel alignments and resealing exterior sealant areas (see Care and Maintenance Section of Owner's Manual); the automotive chassis and power train, including, by way of example the engine, drive-train, steering, ride and handling, braking, wheel balance, muffler, tire wear or failure, tubes, batteries and gauges; appliances and components covered by their own manufacturer's warranty including, by way of example the microwave, refrigerator, ice maker, stove, oven, generator, roof air conditioners, hydraulic jacks, VCR, television(s), water heater, furnace, stereo, radio, compact disc player, washer, dryer, inverter and cellular phone; or flaking, peeling and chips or other defects or damage in or to the exterior or finish caused by rocks or other road hazards, the environment including chemical off-gassing, airborne pollutants, salt, tree sap and hail causing any damage including but not limited to corrosion. Component part and appliance manufacturers issue limited warranties covering those portions of the motor home not covered by the Limited Warranty issued by Warrantor. To learn more on what specific component parts and appliances are excluded from the Limited Warranty issued by Warrantor please contact your selling dealership or Warrantor directly or review the warranty packet inside the Motor home.

EVENTS DISCHARGING WARRANTOR FROM OBLIGATION UNDER WARRANTY

Misuse or neglect, accidents, unauthorized alteration, failure to provide reasonable and necessary maintenance (see Owner's Manual), damage caused by off road use, collision, fire, theft, vandalism, explosions, overloading in excess of rated capacities, and odometer tampering shall discharge Warrantor from any express or implied warranty obligation to repair any resulting defect.

DISCLAIMER OF CONSEQUENTIAL AND INCIDENTAL DAMAGES

THE ORIGINAL PURCHASER OF THE MOTOR HOME AND ANY PERSON TO WHOM THE MOTOR HOME IS TRANSFERRED, AND ANY PERSON WHO IS AN INTENDED OR UNINTENDED USER OR BENEFICIARY OF THE MOTOR HOME, SHALL NOT BE ENTITLED TO RECOVER FROM WARRANTOR ANY CONSEQUENTIAL OR INCIDENTAL DAMAGES RESULTING FROM ANY DEFECT IN THE MOTOR HOME, INCLUDING BY WAY OF EXAMPLE FUEL AND TRANSPORTATION EXPENSES TO DELIVER THE PRODUCT TO THE SERVICING DEALER, HOTEL ROOMS, LOST WAGES AND MOISTURE DAMAGE SUCH AS MOLD AND MILDEW. THE EXCLUSION OF CONSEQUENTIAL AND INCIDENTAL DAMAGES SHALL BE DEEMED INDEPENDENT OF, AND SHALL SURVIVE, ANY FAILURE OF THE ESSENTIAL PURPOSE OF ANY LIMITED REMEDY.

Some states do not allow the exclusion or limitation of consequential or incidental damages, so the above exclusions may not apply to you.

LEGAL REMEDIES

THIS LIMITED WARRANTY DOES NOT "EXTEND TO FUTURE PERFORMANCE". ANY ACTION TO ENFORCE THIS LIMITED WARRANTY OR ANY IMPLIED WARRANTIES SHALL NOT BE COMMENCED MORE THAN 90 DAYS AFTER THE EXPIRATION OF THE WARRANTY COVERAGE PERIOD DESIGNATED ABOVE. IF YOUR MOTOR HOME IS NOT OF THE CURRENT OR PRIOR MODEL YEAR WHEN YOU TAKE DELIVERY OF THE MOTOR HOME OR YOU USE YOUR MOTOR HOME FOR COMMERCIAL OR BUSINESS PURPOSES, ANY ACTION TO ENFORCE THIS LIMITED WARRANTY OR ANY IMPLIED WARRANTIES SHALL NOT BE COMMENCED MORE THAN ONE YEAR AFTER THE EXPIRATION OF THE WARRANTY COVERAGE PERIOD DESIGNATED ABOVE. THE PERFORMANCE OF REPAIRS SHALL NOT SUSPEND THIS LIMITATIONS PERIOD FROM EXPIRING. Some states do not allow the reduction in the statute of limitations, so the above reduction in the statute of limitations may not apply to you.

Warrantor participates in the Consumer Arbitration Program for Recreational Vehicles (CAP-RV). This third-party dispute resolution program is available at no charge to you to settle unresolved warranty disputes. To find out more about the program or to request an application/brochure, please call the Arbitration Administration Office toll free (800) 279-5343. For motor homes purchased in California, the CAP-RV Program operates under the review of the California Arbitration Program. You must utilize this program before claiming rights conferred by 15 USC Section 2310 (Magnuson Moss Warranty Act) or Civil Code Section 1793.22(b) (Song Beverly Warranty Act). You are not required to use this Program if you choose to seek redress by pursuing rights and remedies not conferred by these laws.

THIS WARRANTY GIVES YOU SPECIFIC LEGAL RIGHTS. YOU MAY ALSO HAVE OTHER RIGHTS, WHICH VARY FROM STATE TO STATE.

Julian Date: 042810

LIMITED WARRANTY

SINGLE PAGE WARRANTY

WHAT THE PERIOD OF COVERAGE IS:

This Limited Warranty provided by Four Winds® ("Warrantor") covers those components, assemblies and systems of your new motor home not excluded under the section "What is Not Covered", when sold by an authorized dealer. The duration of the limited warranty ends twelve (12) months after you first take delivery of the motor home from an authorized dealership or after the odometer reaches 15,000 miles, whichever occurs first. However, this Limited Warranty provided by Warrantor covers the steel or aluminum frame structure, only, of the sidewalls (excluding slide outs), roof, and rear and front walls for twenty-four (24) months from the original retail purchase date or the first 24,000 miles of use, whichever occurs first.

If the motor home is not of the current or prior model year when you take delivery of the motor home OR you register your new motor home in a business name or use your motor home for any rental, commercial or business purposes whatsoever, the duration of the limited warranty ends ninety (90) days after you first take delivery of the motor home or after the odometer reaches 5,000 miles, whichever occurs first. The duration of the Limited Warranty covering the steel or aluminum frame structure, only, of the sidewalls (excluding slide outs), roof, and rear and front walls ends twelve (12) months after you first take delivery of the motor home or after the odometer reaches 15,000 miles, whichever occurs first. A conclusive presumption that your motor home has been used for commercial and/or business purposes arises if you have filed a federal or state tax form claiming any business tax benefit related to your ownership of the motor home.

LIMITATION AND DISCLAIMER OF IMPLIED WARRANTIES:

IMPLIED WARRANTIES, IF ANY, ARISING BY WAY OF STATE LAW, INCLUDING ANY IMPLIED WARRANTY OF MERCHANTABILITY AND ANY IMPLIED WARRANTY OF FITNESS FOR A PARTICULAR PURPOSE, ARE LIMITED IN DURATION TO THE TERM OF THIS LIMITED WARRANTY AND ARE LIMITED IN SCOPE OF COVERAGE TO THOSE PORTIONS OF THE MOTOR HOME COVERED BY THIS LIMITED WARRANTY. WARRANTOR DISCLAIMS ALL IMPLIED AND EXPRESS WARRANTIES, INCLUDING THE IMPLIED WARRANTY OF MERCHANTABILITY AND THE IMPLIED WARRANTY OF FITNESS FOR A PARTICULAR PURPOSE, ON COMPONENTS AND APPLIANCES EXCLUDED FROM COVERAGE AS SET FORTH BELOW. There is no warranty of any nature made by Warrantor beyond that contained in this Limited Warranty. No person has authority to enlarge, amend or modify this Limited Warranty. The dealer is not the Warrantor's agent but is an independent entity. Warrantor is not responsible for any undertaking, representation or warranty made by any dealer or other person beyond those expressly set forth in this Limited Warranty. Some states do not allow limitations on how long an implied warranty lasts, so the above limitation may not apply to you.

WHAT THE WARRANTY COVERS:

Warrantor's Limited Warranty covers only defects in the workmanship performed and/or materials used to assemble those portions of your motor home covered by the limited warranty. See also the section "What the Warranty Does Not Cover" set out below. "Defect" means the failure of the workmanship performed and/or materials used to conform to Warrantor's design and manufacturing specification and tolerances.

WHAT WE WILL DO TO CORRECT PROBLEMS:

Warrantor's sole and exclusive obligation is to repair and/or replace, at its option, any covered defect if: (1) you notify Warrantor or one of its authorized servicing dealers of the defect, which is discovered within the warranty coverage period, within ten (10) days of discovering the defect; and (2) you deliver your Motor home to Warrantor or Warrantor's authorized servicing dealer at your cost and expense. It is reasonable to expect some service items to occur during the warranty period. The performance of warranty repairs shall not extend the original warranty coverage period. Further, any performance of repairs after the warranty coverage period has expired or any performance of repairs to component parts and appliances that are excluded from coverage shall be considered "good will" repairs, which shall not alter the express terms of this limited warranty. If the repair or replacement remedy fails to successfully cure a defect after Warrantor received a reasonable opportunity to cure the defect(s), your sole and exclusive remedy shall be limited to Warrantor paying you the cost of having an independent third party perform repairs to the defect(s). Warrantor may use new and/or remanufactured parts and/or components of substantially equal quality to complete any repair. Defects and/or damage to interior and exterior surfaces, trim, upholstery and other appearance items may occur at the factory during manufacture, during delivery of the motor home to the selling dealer or on the selling dealer's lot. Normally, any such defect or damage is detected and corrected at the factory or by the selling dealer during the inspection process performed by the Warrantor and the selling dealer. If, however, you discover any such defect or damage when you take delivery of the motor home, you must notify your dealer or Warrantor within ten days of the date of purchase to have repairs performed to the defect at no cost to you as provided by this Limited Warranty. If two unsuccessful repair attempts have been made to correct any covered defect that you believe substantially impairs the value, use or safety of your motor home, or repairs to any covered defect(s), which you believe substantially impairs the value, use or safety of your motor home, have taken 20 or more days to complete, you must, to the extent permitted by law, notify Warrantor directly in writing of the failure to successfully repair the defect(s) so that Warrantor can become directly involved in exercising a final repair attempt for the purpose of performing a successful repair to the identified defect(s).

Minor adjustments, such as adjustments to the interior or exterior doors, drawers, latches by way of example and not by limitation will be performed by your selling dealer during the first ninety (90) days of warranty coverage. Thereafter, such adjustments are the owner's exclusive responsibility as normal maintenance.

HOW TO GET SERVICE:

The "Acknowledgement of Receipt of Warranty/Product Information" form must be returned to Warrantor promptly upon purchase to assure proper part replacement and repair of your motor home. Failure to return the "Acknowledgement of Receipt of Warranty/Product Information" form will not affect your rights under the Limited Warranty so long as you can furnish proof of purchase. For warranty service simply contact one of Warrantor's authorized service centers for an appointment, then deliver your motor home (at your expense) to the service center.

If you need assistance in locating an authorized warranty service facility, contact Warrantor's Warranty Department (877-TLK 2 TMS or 877-855-2867). The mailing address is: P.O. Box 1486
Elkhart, Indiana 46515-1486

WHAT THE WARRANTY DOES NOT COVER:

This Limited Warranty does not cover: any motor home sold or registered outside of the United States or Canada; items which are added or changed after the motor home leaves Warrantor's possession; items that are working as designed but with which you are unhappy with because of the design; normal wear and usage, such as fading or discoloration of fabrics, or the effects of moisture inside the motor home; defacing, scratching, dents and chips on any surface or fabric of the motor home, not caused by Warrantor; owner maintenance, including by way of example replacement of wiper blades, bulbs, filters, wheel alignments and resealing exterior sealant areas (see Care and Maintenance Section of Owner's Manual); the automotive chassis and power train, including, by way of example the engine, drive-train, steering, ride and handling, braking, wheel balance, muffler, tire wear or failure, tubes, batteries and gauges; appliances and components covered by their own manufacturer's warranty including, by way of example the microwave, refrigerator, ice maker, stove, oven, generator, roof air conditioners, hydraulic jacks, VCR, television(s), water heater, furnace, stereo, radio, compact disc player, washer, dryer, inverter and cellular phone; or flaking, peeling and chips or other defects or damage in or to the exterior or finish caused by rocks or other road hazards, the environment including chemical off-gassing, airborne pollutants, salt, tree sap and hail causing any damage including but not limited to corrosion. Component part and appliance manufacturers issue limited warranties covering those portions of the motor home not covered by the Limited Warranty issued by Warrantor. To learn more on what specific component parts and appliances are excluded from the Limited Warranty issued by Warrantor please contact your selling dealership or Warrantor directly or review the warranty packet inside the Motor home.

EVENTS DISCHARGING WARRANTOR FROM OBLIGATION UNDER WARRANTY:

Misuse or neglect, accidents, unauthorized alteration, failure to provide reasonable and necessary maintenance (see Owner's Manual), damage caused by off road use, collision, fire, theft, vandalism, explosions, overloading in excess of rated capacities, and odometer tampering shall discharge Warrantor from any express or implied warranty obligation to repair any resulting defect.

DISCLAIMER OF CONSEQUENTIAL AND INCIDENTAL DAMAGES:

THE ORIGINAL PURCHASER OF THE MOTOR HOME AND ANY PERSON TO WHOM THE MOTOR HOME IS TRANSFERRED, AND ANY PERSON WHO IS AN INTENDED OR UNINTENDED USER OR BENEFICIARY OF THE MOTOR HOME, SHALL NOT BE ENTITLED TO RECOVER FROM WARRANTOR ANY CONSEQUENTIAL OR INCIDENTAL DAMAGES RESULTING FROM ANY DEFECT IN THE MOTOR HOME, INCLUDING BY WAY OF EXAMPLE FUEL AND TRANSPORTATION EXPENSES TO DELIVER THE PRODUCT TO THE SERVICING DEALER, HOTEL ROOMS, LOST WAGES AND MOISTURE DAMAGE SUCH AS MOLD AND MILDEW. THE EXCLUSION OF CONSEQUENTIAL AND INCIDENTAL DAMAGES SHALL BE DEEMED INDEPENDENT OF, AND SHALL SURVIVE, ANY FAILURE OF THE ESSENTIAL PURPOSE OF ANY LIMITED REMEDY. Some states do not allow the exclusion or limitation of consequential or incidental damages, so the above exclusions may not apply to you.

LEGAL REMEDIES:

THIS LIMITED WARRANTY DOES NOT "EXTEND TO FUTURE PERFORMANCE". ANY ACTION TO ENFORCE THIS LIMITED WARRANTY OR ANY IMPLIED WARRANTIES SHALL NOT BE COMMENCED MORE THAN 90 DAYS AFTER THE EXPIRATION OF THE WARRANTY COVERAGE PERIOD DESIGNATED ABOVE. IF YOUR MOTOR HOME IS NOT OF THE CURRENT OR PRIOR MODEL YEAR WHEN YOU TAKE DELIVERY OF THE MOTOR HOME OR YOU USE YOUR MOTOR HOME FOR COMMERCIAL OR BUSINESS PURPOSES, ANY ACTION TO ENFORCE THIS LIMITED WARRANTY OR ANY IMPLIED WARRANTIES SHALL NOT BE COMMENCED MORE THAN ONE YEAR AFTER THE EXPIRATION OF THE WARRANTY COVERAGE PERIOD DESIGNATED ABOVE. THE PERFORMANCE OF REPAIRS SHALL NOT SUSPEND THIS LIMITATIONS PERIOD FROM EXPIRING. Some states do not allow the reduction in the statute of limitations, so the above reduction in the statute of limitations may not apply to you.

Warrantor participates in the Consumer Arbitration Program for Recreational Vehicles (CAP-RV). This third-party dispute resolution program is available at no charge to you to settle unresolved warranty disputes. To find out more about the program or to request an application/brochure, please call the Arbitration Administration Office toll free (800) 279-5343. For motor homes purchased in California, the CAP-RV Program operates under the review of the California Arbitration Program. You must utilize this program before claiming rights conferred by 15 USC Section 2310 (Magnuson Moss Warranty Act) or Civil Code Section 1793.22(b) (Song Beverly Warranty Act). You are not required to use this Program if you choose to seek redress by pursuing rights and remedies not conferred by these laws.

THIS WARRANTY GIVES YOU SPECIFIC LEGAL RIGHTS. YOU MAY ALSO HAVE OTHER RIGHTS, WHICH VARY FROM STATE TO STATE.

Julian Date: 042810

Registration And Acknowledgement of Receipt of Warranty and Product Information



IMPORTANT: THE CUSTOMER IS REQUIRED TO READ THIS DOCUMENT BEFORE SIGNING IT.

We have listed several items which will help acquaint you with your new recreation vehicle. You the purchaser, should not submit this form until (1) you have received and reviewed the Limited Warranty and owner's manual; (2) you have had the opportunity to inspect and operate the vehicle; (3) all items have been demonstrated and/or explained to you; (4) the dealer has answered any questions you may have, and; (5) you find the vehicle in good condition. The dealer is not authorized to deliver this vehicle until this has been done and both you and the dealer have signed this form.

PRODUCT LINE SERIAL NUMBER
YEAR VIN NUMBER
OWNER'S LAST NAME OWNER'S FIRST NAME
STREET ADDRESS CITY
STATE ZIP COUNTRY PHONE
OWNER'S EMAIL RETAIL DELIVERY DATE

Owner/Dealer Inspection

- 1. Exterior and interior finish
2. Operate all appliances (electrical and gas)
a. Furnace and thermostat (lighting and maintenance)
b. Range and oven (lighting and maintenance)
c. Water heater (lighting and maintenance)
d. Refrigerator (operation and maintenance)
3. Operate 120 Volt generator (if so equipped)
4. Operate all doors and windows including locks
5. Operate plumbing facilities including water faucet's, shower and toilet
6. Observe or check to assure that all wheel lugs are tight and tire pressure is correct
7. Review operation of manual or automatic Propane Gas regulator
8. Operate all air conditioners, radio, entertainment system and televisions (if so equipped)
9. Complete review of owner's manual by dealer with owner
10. Test drive
11. Odometer reading as observed by customer is:
MILES OR KILOMETERS

I have completed the above inspection on this recreation vehicle and have taken the test drive at the time of purchase. I noted the following issues:

I received and read the final stage manufacturer's 1 page Limited Warranty, published within the Owner's Manual, and the Chassis Limited Warranty, both of which were made available to me, before I purchased the vehicle and agreed to the terms and conditions therein. I understand that the vehicle is to be used only for travel on improved roads. I also understand that the selling dealer is not an agent for the final stage manufacturer but is an independent company with no authority to make any representation or promise for the final stage manufacturer.

I acknowledge that the chassis, component parts and appliances that are separately covered by another manufacturer's warranty are excluded from coverage under the Manufacturers Limited Warranty. I understand that this form is for product registration purposes and failure to return this form does not diminish my warranty rights during the warranty period.

PURCHASER SIGNATURE DATE DEALER SIGNATURE DATE

I have inspected, or been given the opportunity to inspect the vehicle; taken a test drive of the vehicle and, I have made notations of defects I discovered in the space provided.

SALES PERSON LAST NAME SALES PERSON FIRST NAME

SELLER DEALER DATE

Dealer is to ensure this form is properly completed and returned to Thor Motorized Services within fifteen (15) days after delivery. Return this page to: Thor Motorized Services, 701 C.R. 15, Elkhart, Indiana 46517 • E-mail: Registrations@ThorMotorizedServices.com • Fax: 574-294-3618

THIS PAGE IS INTENTIONALLY LEFT BLANK

GENERAL INFORMATION

CONGRATULATIONS!



Congratulations on your recent purchase of a Four Winds International Recreational Vehicle. We sincerely thank you for choosing Four Winds, and we would like you to know that your satisfaction is of great importance to us.

In the next coming weeks you will receive a courtesy call by our Concierge Connection, your personal service advocate. The concierge will explain your warranty, answer any questions you might have, supply contact information on your local dealer, and more importantly follow up with you in three months.

Thor Motorized Services is the service support for Four Winds International. TMS was developed to streamline technical assistance, warranty claims, authorization requests, and parts for our dealer network and owners. This relationship will greatly improve our partnership with you, and the dealers. In addition, we value you and your input. Please feel free to contact us and share your thoughts.

This manual describes many features of your motor home, and provides a guide to operating procedures, so that you can obtain the best performance. Like all automotive equipment, your motor home will require care, and regular maintenance, in order to retain its maximum performance characteristics, and help you enjoy many miles and years of recreational living. The instruction manuals and literature provided by the leading appliance manufacturers and the chassis operator's manual located in your owner's bag, will provide a working knowledge of your unit and how to care for it. If you have any questions regarding operation, maintenance, or service, please contact your local dealer, or Thor Motorized Services direct at (877) **TLK-2-TMS** or WarrantySupport@ThorMotorizedServices.com.



Exceeding Expectations

Building Relationships

Fostering Loyalty

ABOUT THIS OWNER'S MANUAL

The following information reflects product design, fabrication, and component parts at the time of printing. Four Winds International Corporation reserves the right, at anytime, to make changes in product design, material or component specifications at its sole option without notice. This includes the substitution of components of different brand or manufacturer name, which results in comparable performance.

Your actual motor home may vary from this document as a result of optional equipment offered on this model and year of motor home. In the case that you are not the initial retail owner of this unit, this document will not reflect modifications that may have been performed by previous owners. Photographs, line art, and diagrams contained herein may reflect both standard and optional equipment at the time of printing.

All information printed in this Owner's Manual is subject to change after the date of printing. Due to product improvements and changes during the model year, information represented within this Owner's Manual may not be accurate at the time of your purchase. If certain information is significant to your purchasing decision or in the performance of a repair, please confirm the accuracy of the information with your dealership or the manufacturer before relying upon the information within this Owner's Manual.

SYMBOLS

The following safety alert symbols are used throughout this manual to call attention to warnings where possible personal injury or vehicle damage may be involved.



DANGER indicates an hazardous situation which, if not avoided, will result in death or serious injury.



WARNING indicates a hazardous situation which, if not avoided, could result in death or serious injury.



CAUTION indicates a hazardous situation which, if not avoided, may result in minor or moderate injury.

NOTICE

NOTICE indicates a hazardous situation which, if not avoided, may result in property damage.



GAS ONLY indicates instructions that are specific to coaches with a gasoline engine.



DIESEL ONLY indicates instructions that are specific to coaches with a diesel engine.

MANUFACTURERS WARRANTIES

The following list of components has been compiled to help you know which products on your motor home may have their own warranties. If you have any of these components on your motor home, be sure to check the literature supplied by the manufacturer to see if they require that you register your purchase with them to validate their warranty. We recommend that you send the various warranty registration cards immediately before any time constraints on registration expire. Manufacturer's literature is contained in a separate packet furnished with the owner's manual on newly delivered units. Only those products and options which are on your motor home will be included in this packet. You should go over this literature with your dealer during the pre-delivery inspection. Any shortages of literature should be reported to the dealer at that time.

Appliances

- Air Conditioner (Roof)
- Awnings
- Back-up Monitor
- Central Vacuum
- DVD Player
- Fireplace
- Furnace
- Home Theater System
- Ice Maker
- Microwave
- Radios
- Range and Cooktop

Refrigerator

- Roof Vents

Water & Drainage

- Toilet
- Washer/Dryer Combo
- Water Faucets
- Water Filter
- Water Heater
- Water Pump

Chassis

- Air Conditioner
- Batteries
- Cruise Control

Leveling Jacks

Propane

- Propane Gas Tank
- Regulator

Electrical

- Battery
- Converter
- Electrical Entry Step
- Generator
- GFCI Receptcs
- Inverter
- Propane Gas Leak Detector

VENDOR CONTACT INFORMATION

Allison Transmission

800-524-2303
www.allisontransmission.com

ASA Electronics

800-688-3135
www.asaelectronics.com

Atwood Mobile Products, Inc.

800-825-4328
www.atwoodmobile.com

Caterpillar

877-777-3126
www.cat.com

Coach-Net

877-801-0333
www.coach-net.com

Cobra Electronics Corp.

773-889-3087
www.cobra.com

Cummins

800-343-7357
www.mantank.com

Detroit Diesel

800-445-1980
www.detroitdiesel.com

Dometic

800-544-4881
www.dometicus.com

Evans Tempcon

800-878-7147
www.evanstempcon.com

Equalizer Systems

574-264-3437
www.equalizersystems.com

Fantastic Vent

800-521-0298
www.fantasticvent.com

First Alert

800-323-9005
www.firstalert.com

Flair Interiors

574-534-2163
www.flairinteriors.com

Flexsteel Industries

574-831-4050
www.flexsteel.com

Four Winds Int.

(877)TLK-2-TMS
www.fourwinds-rv.com

Ford

800-392-3673
www.Ford.com

Freightliner

800-385-4357
www.freightlinerchassis.com

GM

800-353-3867
www.gmfleet.com

Good Year

800-321-2136
www.goodyear.com

Hehr International, Inc.

574-935-5122
www.hehr-international.com

HWH Corporation

800-494-3213
www.hwhcorp.com

Intellitec

800-251-2408
www.intellitec.com

KIB Enterprises

800-250-7051
www.kibenterprises.com

KVH Industries, Inc.

401-847-3327
www.kvh.com

Kwikee Products Co. Inc.

800-736-9961
www.kwikee.com

Lippert Components

574-534-0001
www.lci1.com.com

Magnum Energy

425-353-8833
www.magnumenergy.com

Manchester Tank

800-877-8265
www.mantank.com

Michelin

800-847-3435
www.michelin.com

Mor/ryde

574-293-1581
www.morryde.com

MTI Industries, Inc.

800-383-0269
www.mtiindustries.com

Norcold

800-543-1219
www.norcold.com

Onan

800-888-6626
www.onan.com

Scope Technologies

574-295-0229
www.scopetechnologies.com

Select Comfort

888-580-9237
www.selectcomfort.com

Sharp

800-237-4277
www.sharppusa.com

SHURflo, LLC

800-854-3218
www.shurflo.com

Splendide

800-356-0766
www.splendide.com

TDI Products

866-713-1489
www.tdiproducts.com

Theftford

800-521-3032
www.theftford.com

TriMark Corp.

800-431-8616
www.trimarkcorp.com

Velvac

800-783-8871
www.velvac.com

Viracon

800-533-0482
www.viracon-autoglass.com

Visteon Corp.

800-847-8366
www.visteon.com

Winegard Co.

800-288-8094
www.winegard.com

Workhorse

800-877-294-6773
www.workhorse.com

MOTOR HOME LOAD LIMITS

Occupant And Cargo Carrying Capacity

Your motor home is designed to carry the loads defined by the **Gross Axle Weight Rating** (GAWR - the value specified by the chassis manufacturer as the load carrying capacity of a single axle system, as measured at the tire/ground interface.) The **Gross Vehicle Weight Rating** (GVWR - the maximum permissible loaded weight of the motor home) is shown on the vehicle information sticker posted near the driver's side front window or inside the driver's side door jam. These ratings are for a fully loaded vehicle including passengers and normal belongings

⚠ WARNING **EXCEEDING THE GAWR OR GVWR OF YOUR MOTOR HOME CAN CAUSE UNDESIRABLE HANDLING CHARACTERISTICS** and may even create a safety hazard. Modification of your vehicle to carry additional equipment or vehicles is not recommended and may void your warranty.

 **Note:** Be sure the weight of passengers, equipment and supplies does not cause your motor home to exceed axle loads and overall vehicle loads for which it was designed. If in doubt, weigh the vehicle at a public scale. Keep in mind the number of safety belts in a unit are there for the convenience and use of the owner. Carrying the number of people equal to the number of seat belts may exceed the weight ratings. A motor home has the potential to be overloaded and removal or redistribution of weight may be necessary from time to time to stay within weight ratings. Your motor home includes a "Weight Information Label." This label provides specific weight information for your motor home as a guideline so that you can determine the load carrying capabilities.

The Four Winds Motor Home WEIGHT SPECIFICATIONS yellow label concisely states the occupant and cargo carrying capacity of your motor home (per the requirements of 49 CFR part 571.120 as issued by the National Highway Traffic Safety Administration - NHTSA).

The yellow MOTOR HOME OCCUPANT AND CARGO CARRYING CAPACITY weight label is affixed to the interior side of the forward-most door of your motor home on the passenger side This label indicated how much weight you can safely carry within the vehicle.

For a Class C:	The label is affixed directly to the door front door jamb.
For a Class A:	The label is affixed to the entrance door, directly below the window screen
For a Diesel:	The label is affixed to the entrance door, directly below the window screen

The total weight of passengers, cargo, trailer tongue weight, and water should never exceed the value shown on the label.

A typical example of this label is shown below for reference purposes only. The numbers shown on this page may not be applicable to your vehicle. Please reference the Yellow label affixed directly to the door of your motor home for your actual Occupant and Cargo Carrying Capacity:

<p>MOTOR HOME OCCUPANT AND CARGO CARRYING CAPACITY VIN# 1FDXE4##### THE COMBINED WEIGHT OF OCCUPANTS AND CARGO SHOULD NEVER EXCEED: 970 kg or 2140 lbs Safety belt equipped seating capacity: 7 CAUTION: A full load of water equals 173 kg or 382 lbs of cargo @ 1kb/L (8.3 lb/gal) and the tongue weight of a towed trailer counts as cargo</p>

NOTICE

DO NOT OVERLOAD THE MOTOR HOME.

When loading your cargo, be sure it is distributed evenly to prevent overloading front to back and side to side. Heavy items should be placed low and as close to the axle positions as reasonable. Too many items on one side may overload a tire.

VEHICLE WEIGHING PROCEDURES

Periodically weigh the motor home at a public scale to determine axle loads. The following procedure is suggested, although any method recommended by the scale operator which correctly determines weight value is acceptable. During all measurements, it is important to keep the vehicle as level as possible.

Where To Weigh Your Motor Home

To weigh your motor home correctly, measure the fully loaded vehicle axle by axle and wheel position by wheel position. You can find several certified public or commercial scales at moving and storage lots, farm suppliers with grain elevators, gravel pits, recycling companies and large commercial truck stops. You can also look in the telephone book under "weighers" or "weighing". Allow adequate time, since the entire weighing process can take up to 30 minutes. There may be a small fee for each weight taken, but the expense is a worth while investment toward the safe and economical operation of your motor home.

How To Weigh Your Motor Home

Your motor home must be weighed fully loaded. That is with passengers, food, clothing, fuel, water, propane, supplies etc. Any towed vehicle (car/pickup, boat, or trailer) or item loaded on brackets on the back of the motor home should also be included in the weighing.

1. The following steps are suggested when using a long platform scale:
 - a. Pull onto the scale so that only the front axle is on the platform (with the end of the scale midway between the front and rear axles) and record the scaled weight.
 - b. Pull forward until the full unit is on the scale and record the weight.
 - c. Pull forward so that only the rear axle is on the scale and record the weight.
 - d. If a boat, trailer or other vehicle is being towed, it should be weighed and combined with the towing vehicle's weight to ensure the total weight does not exceed the GCWR.

 **Note:** Even though the weight of the total axle may be within the axle's rating, it may be overloaded on one side. This causes one wheel position to be overloaded. Therefore, side-to-side weighing should be done.

To obtain the individual wheel position weights, repeat this process with only one side of the motor home on the scale. To determine individual wheel position weights, it is necessary to repeat the previous three steps (1a, 1b, and 1c), but this time, use only one side of the scale. To calculate the opposite side of the vehicle wheel position weight, subtract this side's weights from the weights recorded in steps 1a, 1b, and 1c.

Your motor home must remain as level as possible on the scale, even though an axle or side is not physically on the scale. To obtain the side-to-side weights, there must be enough space on either side of the scale to allow the motor home to be partially off the scale.

Individual wheel position weights must not exceed the maximum tire load capacity.

⚠ CAUTION Maximum tire load capacity can only be achieved by utilizing the maximum allowable pressure (psi) as listed on the sidewall of the tire.

 **Note:** The above information is provided by the Tire Industry Safety Council Rubber Manufacturer's Association. Used with permission. (http://www.rma.org/tire_safety/)

2. For improved accuracy, Four Winds recommends using a segmented 4-pad scale, when possible, to determine individual wheel weights. The corner weights should not exceed half of the respective Gross Axle Weight Rating (GAWR) or the maximum load rating for the tire or set of dual tires at the rear, whichever is less. The maximum load rating for the tire can be found embossed on the tire's sidewall. If any of the corner weights exceed half of the listed GAWR or tire ratings, relocate the passengers and redistribute or remove a portion of the cargo until the weight is within the proper limits for all four corners of the vehicle.

 **Note:** Additional cargo carrying capacity can be obtained by reducing the amount of fresh water carried while driving.

Check vehicle weight periodically to obtain optimum mileage from tires and improve handling. Tires should always be inflated as recommended in the chassis manufacturer's instructions or on the tire sidewall. See your chassis operators manual.

Improper weight distribution or too much weight on your motor homes suspension system can cause spring, shock absorber, or brake failure, handling or steering problems, irregular tire wear, tire failure or other damage.

An overloaded motor home is hard to drive and hard to stop. In cases of serious overloading, brakes can fail completely, particularly on steep hills. The load a tire will carry safely is a combination of the size of tire, its load range, and corresponding inflation pressure.

Weight Terms

The following is an explanation of commonly used weight abbreviations.

- **Gross Vehicle Weight Rating (GVWR)** is the maximum permissible weight of this motor home.
- **Unloaded Vehicle Weight (UVW)** is the weight of this motor home as manufactured at the factory with full fuel, engine oil, and coolants.
- **Occupant and Cargo Carrying Capacity (OCCC)** is equal to the GVWR minus UVW and LP. In other words, OCCC is how much weight in occupants, cargo , water and trailer tongue weight that can be added to the motor home without exceeding the GVWR.
- **Gross Combined Weight Rating (GCWR)** means the maximum allowable loaded weight of this recreation vehicle with its towed trailer or towed vehicle.
- **Gross Axle Weight Rating (GAWR)** is the value specified as the load carrying capacity of a single axle system, as measured at the tire-ground interfaces.

IDENTIFICATION AND SAFETY

REPORTING SAFETY DEFECTS

If you believe that your motor home has a defect which could cause a crash or could cause injury or death, you should immediately inform the National Highway Traffic Safety Administration (NHTSA) in addition to notifying Four Winds International.

If NHTSA receives similar complaints, it may open an investigation, and if it finds that a safety defect exists in a group of vehicles, it may order a recall and remedy campaign. However, NHTSA cannot become involved in individual problems between you, your dealer, or Four Winds International.

To contact **NHTSA**, you may either call the Auto Safety Hot line toll-free at 1-888-327-4236 (TTY: 1-800-424-9153); go to <http://www.safecar.gov>; or write to: **Administrator, NHTSA, 1200 New Jersey Avenue, S.E., Washington, DC 20590.**

You can also obtain other information about motor vehicle safety from <http://www.safecar.gov>.

LAWS OF THE ROAD

It is advisable to contact the Department of Motor Vehicles in each respective state, for up-to-date information regarding operation and licensing requirements for your particular motor home.

The state of California currently requires operators of motor homes over 40 feet in length to obtain a non-commercial class B license. California has also enacted legislation limiting use of motor homes in excess of 40 feet, to approved roadways. You may contact Caltrans at www.dot.ca.gov or 916-654-5741 for current information regarding these California statutes.

MOTOR HOME SERIAL NUMBER DECAL AND DATA PLATES

The motor home serial number label is mounted on the inside wall next to the driver’s seat on a Class A motor home and on the inside of the driver’s door post on a Mini motor home. Refer to the chassis owner’s manual for the location of the chassis vehicle identification number on all motorized motor homes.

 **Note:** Always give model, year, and the V.I.N. number information when ordering parts. Also, we recommend that you keep a copy of this information separate from the motor home in the event theft or vandalism requires you to supply a copy to the authorities.

Decals and data plates used throughout the motor home aid in its safe and efficient operation; others give service instructions. Read all decals, data, and instruction plates before operating your motor home.

 **Note:** When any decal, data, or instruction plate is damaged, painted over, removed, etc.; the item should be replaced immediately.

MANUFACTURED BY: FOUR WINDS INTERNATIONAL INC. VEH. MFG. BY:	MODEL: SERIAL:	Offline: Received:
<u>KG (LB)</u>	<u>TIRES</u>	<u>RIMS</u>
	<u>COLD INFLATION PRESSURE</u>	<u>SINGLE</u>
		<u>DUAL</u>
GVWR:		
GAWR FRONT:		<input checked="" type="checkbox"/>
GAWR INTERM:		<input type="checkbox"/>
GAWR REAR:		<input checked="" type="checkbox"/>

THIS VEHICLE CONFORMS TO ALL APPLICABLE U.S. FEDERAL MOTOR VEHICLE SAFETY STANDARDS IN EFFECT IN:
 V.I.N.: TYPE: MULTI-PASSENGER VEHICLE

SAFETY REGULATIONS FOR PROPANE GAS SYSTEMS AND APPLIANCES

The following warnings are posted throughout the motor home to provide information on Propane safety. They have been installed not only because of the requirement to do so, but also as a constant reminder to occupants of the motor home to exercise proper caution when using or being around Propane appliances and equipment. We are listing them here so you may study them and make sure that you and your family understand and follow them.

⚠ WARNING It is not safe to use cooking appliances for comfort heating. Cooking appliances need fresh air for safe operation.

⚠ WARNING To ensure proper ventilation before operating a propane appliances you should open overhead vents, turn on the exhaust fan, and open a window.

Warning labels are located in the cooking area to remind you to provide an adequate supply of fresh air for combustion. Unlike homes, the amount of oxygen supply is limited due to the size of the motor home, and proper ventilation when using the cooking appliances will avoid dangers of asphyxiation.

Over-filling the Propane gas tank can result in uncontrolled gas flow which can cause fire or explosion. A properly filled tank will contain approximately 80% of its volume as liquid Propane. An 80% automatic shut-off valve is installed on the Propane gas tank which will automatically prevent further filling when the gas volume has reached 80% of tank capacity.

⚠ CAUTION This tank is equipped with an automatic valve designed to close at 80% liquid full. Always open 20% fixed liquid level bleeder gauge while filling. Stop filling if liquid appears before valve shuts off.

⚠ WARNING All Propane gas is contained under pressure. Due to the dangerous potential of any compressed gas, it is mandatory that the following requirements for the use of this tank be followed: Tanks are to be installed, fueled and maintained in accordance with the state and local codes, rules, regulations or laws and in accordance with the NFPA Pamphlet 58, division IV.

Only personnel trained in the handling of Propane may fill, test or repair the Propane gas system.

⚠ WARNING If you smell gas, extinguish any open flames, pilot lights, and all smoking materials. **DO NOT** touch electrical switches. Shut off the gas supply at the tank valve(s) or gas supply connection. Open doors and other ventilation openings. (do not use the range hood) Leave the area until the odor clears and have the system checked by a trained professional before using again.

Propane gas regulators must always be installed with the diaphragm vent facing downward. Regulators that are not in compartments have been equipped with a protective cover. Make sure that the regulator vent faces downward and the cover is kept in place to minimize vent blockage which could result in excessive gas pressure causing fire or explosion

⚠ WARNING Portable fuel burning equipment including wood or charcoal burning grills and stoves should not be used inside the motor home because they may cause fire or asphyxiation.

FIRE SAFETY

Fire safety is an important part of owning a motor home. Make sure that everyone traveling in the motor home is familiar with the location of exits, including emergency exit windows should an emergency arise. The following basic rules of fire prevention can help eliminate the possibility of a fire.

- Never store flammable liquids within the motor home
- Keep cooking surfaces clean
- Never clean with a flammable liquid
- Never leave cooking food unattended
- Never smoke in bed, and always use an ashtray
- Never allow children to play with Propane gas or electrical equipment
- Never use an open flame as a flashlight
- Always repair faulty or damaged wiring and electrical components
- Never overload electrical circuits
- Locate and repair Propane gas leaks immediately
- Don't allow rubbish to accumulate
- Spray fabrics annually with a flame retardant

If a fire does start, make sure to follow these basic rules of safety:

1. Have everyone evacuate the motor home as quickly as possible
2. After everyone is clear, check the fire to see if you can attempt to put it out. If it is too large, or the fire is fuel fed, get clear of the motor home and have the fire department handle the emergency.
3. **DO NOT** attempt to use water to put out the fire. Water can spread some types of fire, and electrocution is possible with an electrical fire.

⚠ WARNING **DO NOT** store Propane containers inside the motor home. Propane containers are equipped with safety devices which relieve excessive pressure by discharging gas to the atmosphere. Failure to comply could result in explosion resulting in death or serious injury.

FIRE EXTINGUISHER

Underwriter Laboratories classify fires into three types:

Class A: Fires in wood, paper, fabric, rubber, and certain plastics

Class B: Flammable liquids such as grease, cooking oils, gasoline, or kerosene

Class C: Electrical fires started from live electrical wires, from short circuits motors or switches

The fire extinguisher, which is located by the entry door of the motor home, is a chemical type suitable for extinguishing small fires of the class B or C type. Extinguishers are designed to put out fires in the initial stage, not when it is blazing out of control. If a fire cannot be approached within 10', the extinguisher will not be effective.

To fight a fire with an extinguisher, first remove the tamper tape which covers the discharge push button. Hold it upright and stand six to ten feet from the fire with a clear path to an exit. Press the button down all the way, aimed at the base of the fire and spray with quick motions from side to side.

Avoid inhaling the dry chemicals. Although nontoxic, they could cause temporary irritation and vomiting. When the fire is out, clean up the area as soon as possible. The dry chemicals are non-corrosive, but some residue may cause surface damage if left too long.

In the case of an electrical fire, disconnect the battery and throw off the main circuit in the unit. It is important that everyone knows where to find the main circuit and how it operates. If the shoreline power cord is connected, disconnect it.

To keep the fire extinguisher in proper operating conditions:

1. **Check Pressure** monthly or more often. Check the nozzle for obstruction. Press the green pin below the nozzle. If it returns and sticks out from the extinguisher, it is operable. If the pin does not come back, discard extinguisher. Refillable models have a pressure gauge to check.
2. Check the **Tamper Tape** to make sure it is intact. DO NOT test the extinguisher. Even a partial discharge may cause leakage.
3. When checking the extinguisher for pressure, enter the date checked on the **Inspection Tag** furnished with the motor home. Regular inspections will help insure the condition.
4. **Agitate Dry Chemical** every six (6) months, by inverting the bottle and lightly shaking for several seconds. This will help prevent the dry chemical from settling due to in motion vibrations.

CARBON MONOXIDE AND SMOKE DETECTORS

⚠ WARNING Both the **Smoke Alarm** and the **Carbon Monoxide alarm** cannot operate without a 9 Volt battery. Removing the battery for any reason, or failing to replace the battery at the end of it's service life, removes your protection. Refer to the manufacturers owner's manual for proper replacement batteries.



Both the **Smoke Alarm** and the **Carbon Monoxide alarm** cannot operate without a 9 Volt battery. Removing the battery for any reason, or failing to replace the battery at the end of it's service life, removes your protection. Refer to the manufacturers owner's manual for proper replacement batteries.

The smoke alarm will only indicate the presence of smoke that reaches the sensor. The smoke alarm is not designed to sense gas, heat or flames. The

CO alarm is not designed to detect fire or any other gas. It will only indicate the presence of CO gas at the sensor. CO may be present in other areas.

For instruction on programming the alarm refer to the Smoke Alarm User's



Testing Procedure

⚠ WARNING DO NOT stand close to the alarm when the horn is sounding. Exposure at close range may be harmful to your hearing. When testing, step away when the horn starts sounding.

Never use an open flame of any kind to test this unit. The built-in test switch accurately tests the unit's operation as required by Underwriters Laboratories, Inc. (UL).

TEST: It is important to test this unit every week to make sure it is working properly. Using the test button is the recommended way to test this Smoke Alarm. Press and hold the test button on the cover of the unit until the alarm sounds (the unit may continue to alarm for a few seconds after you release the button). If it does not alarm, make sure the unit is receiving power and test it again. If it still does not alarm, replace it immediately. During testing you will hear a loud, repeating horn pattern: 3 beeps, pause, 3 beeps, pause; and the Red LED will flash rapidly.

 **Note:** If the unit does not alarm, make sure the batteries are correctly installed, and test again. If the unit still does not alarm, replace it immediately.

Regular Maintenance

This unit has been designed to be as maintenance free as possible, but there are a few simple things you must do to keep it working properly. Use only the replacement batteries listed below. The unit may not operate properly with other batteries. Never use rechargeable batteries since they may not provide a constant charge.

- Test it at least once a week.
- Clean the Smoke Alarm at least once a month; gently vacuum the outside of the Smoke Alarm using your house hold vacuum's soft brush attachment. Test the Smoke Alarm. Never use water, cleaners or solvents since they may damage the unit.
- If the Smoke Alarm becomes contaminated by excessive dirt, dust and/or grime, and cannot be cleaned to avoid unwanted alarms, replace the unit immediately.
- Relocate the unit if it sounds frequent unwanted alarms. See product manual under "Locations to Avoid for Smoke Alarms" for details.
- When the battery becomes weak, the Smoke Alarm unit will "chirp" about once a minute (the low battery warning). This low battery warning should last 7 days, but you should replace the battery immediately to continue your protection. Note: If locking pin is engaged see "Locking Feature" section for unlocking instructions.

Choosing a replacement battery:

Your Smoke Alarm requires one standard 9V battery. The following batteries are acceptable as replacements: Duracell #MN1604, (Ultra) #MX1604; Eveready (Energizer) #522. You may also use a Lithium battery like the Ultralife U9VL-J for longer service life between battery changes.

Carbon Monoxide Safety Precautions

⚠ WARNING DO NOT alter or modify any component of the exhaust system at any time. Inspect the exhaust system at regular intervals for damage. If you suspect or locate damage to the system, have it repaired immediately by a qualified service facility.

Never sleep while the engine or generator is running. Be aware of carbon monoxide poisoning and its symptoms: Dizziness, Severe Headache, Vomiting, Weakness, Sleepiness, Muscular Twitching, and Throbbing in Temples. If anyone in the motor home experiences any of these symptoms, shut off the engine, and immediately go outside into fresh air. Get medical attention as soon as possible.

Carbon Monoxide cannot be seen or smelled and can kill you. If alarm sounds: Turn off appliances, as well as other sources of combustion at once (furnace, water heater, stove, motor home, automobile, etc.) and call the fire department. Get fresh air into the premises or vehicle. Have the problem corrected before starting any appliances or the vehicle.

Never run the engine or generator unless you are sure that exhaust gases will be safely dispersed into the atmosphere. Always be sure that exhaust tail pipes remain unblocked and windows near the exhaust are closed.

PROPANE GAS DETECTOR

The Propane Gas Detector is powered at all times when the coach battery disconnect switch is in the ON position. When power is supplied to the detector the green indicator light will illuminate. After 60 seconds, the detector will begin monitoring the air in the motor home for combustible vapors. The Propane you use to cook, refrigerate, and heat is combustible. Should a leak occur, the detector will produce a pulsating alert sound when the gas reaches the detector. This alert will continue to sound until the gas has dissipated or until the reset button is pressed. When the alert sounds, open all doors and major windows to air out the motor home and turn the gas off at the tank. Do not reenter the motor home until the alert stops sounding. If the alert sounds a second time after the gas is turned back on, leave the gas off and have a qualified Propane Dealer or Motor Home Service Center make the necessary repairs. The reset button only stops the alert from sounding for 60 seconds. This device is intended for detection of Propane gas ONLY.



Maintenance

NOTICE

NEVER USE WATER, CLEANERS OR SOLVENTS TO CLEAN THE DETECTOR.

The following maintenance steps should be taken to ensure proper function of the detector.

- Test the detector at least once per week.
- Clean the detector at least once a month; gently vacuum the outside of the detector using the vacuum's soft brush attachment.
- If detector becomes contaminated by excessive dirt, dust and/or grime, and cannot be cleaned to avoid unwanted alarms, replace the unit immediately.

How To Test

⚠ WARNING NEVER USE AN OPEN FLAME OF ANY KIND TO TEST THIS UNIT. The built-in test switch accurately tests the unit's operation as required by Underwriters Laboratories, Inc. (UL)

Simply press the TEST switch any time during the warm-up cycle or while in normal operation. The LED should flash red and the alarm should sound. Release the switch. This is the only way you should test your detector. The test feature checks the full operation of the detector. If this detector does not test properly return it immediately for repair or replacement.

TEST: This test procedure should be repeated every week or every time the motor home is taken on a trip.

 **Note:** Refer to the detector manufacturer if you have any questions about the Propane Gas Detector.

Checking the Propane System for Leaks

▲ WARNING Road vibration can loosen Propane fittings. It is important to check the Propane system for leaks at least every 5,000 miles, and whenever the tank is filled. It is also a good idea to have the entire Propane system checked annually by a qualified Propane service representative.

Use the following steps when checking the system for leaks:

1. Open all the windows and vents.
2. Open the gas tank service valve.
3. Use non-ammoniate, non-chlorinated soap solution, or an approved leak detection solution on all line connections (ammoniate soap solutions can cause cracking on copper or brass lines and fittings).
4. If a leak is detected, tighten the connection with two open end wrenches until bubbling stops. DO NOT over tighten, or use excessive force. If the leak continues, contact the motor home dealer, or a qualified Propane service representative to have an 11" Water Column Test performed.

About the Propane Gas Detector

Liquefied Petroleum Gas (Propane) is heavier than air and will settle to the lowest point which is generally the floor of the motor home. The detector is also sensitive to other fumes such as hair spray of which most contain butane as the propellant. Butane, like Propane, is heavier than air and will settle to the floor level where it will be detected. When this occurs, press the reset button to stop the alert sound for 60 seconds.

The Propane Gas Detector is powered by the motor home coach batteries and/or the inverter. The detector will operate properly until the battery is drained down to 10 volts (a low battery condition is 10.4 volts). If the power source (battery and/or inverter) is disconnected, or if the power is otherwise interrupted, the detector will not operate.

The Propane Gas Detector has a self check circuit which runs at all times when the detector is powered. In the event that the circuitry fails, a failure alarm will sound. It is a continuous series of short beep tones between long intervals and is distinctively different from the alert sound.

Most Common Causes of Apparent Malfunction

New Coach Odor: The glues and other materials used in manufacturing the coach produce vapors which may be detected when the coach is closed up. Air out the motor home thoroughly.

Keeps Beeping: The gas detector beeps about once every minute, even when it is turned off. The problem is a weak battery in the smoke detector, similar to the alert sound of the Propane Gas Detector.

Hair Spray Triggers the Detector: Most aerosol hair sprays use butane gas as the propellant. Butane, like Propane, is heavier than air and will settle to the floor level where it will be detected.

Other Gases: Other gases which can cause the detector to respond with an alert include the vapors from any fuel, liquor, alcohol, deodorants, colognes, perfumes, wine, adhesives, lacquer, and most cleaning agents.

Slow Beep Rate: This could be the failure alarm and will occur in the event that the circuitry fails. It is a continuous series of short beep tones between long intervals and is distinctively different from the alert sound.

If the problem still exists: Contact MTI Industries for assistance.

 **Note:** The Propane Gas Detector enters a cleaning and initializing mode every time it is powered. If turned OFF for less than 15 minutes, the Propane Gas Detector may produce several short "chirps" within the first 80 seconds of operation. This is a normal function of the LP Gas Detector.

See your Four Winds International Dealer or a qualified Propane Service Center should service be required. If they are not familiar with this product, have them call the detector manufacturer for assistance. If service is not available in your area, call MTI Industries.

CHEMICAL SENSITIVITY



After you first purchase your new motor home and sometimes after it has been closed up for an extended period of time you may notice a strong odor and chemical sensitivity. This is not a defect in your motor home. Like your home, there are many different products used in the construction of motor homes such as carpet, linoleum, plywood, insulation, upholstery, etc. Formaldehyde is also the by-product of combustion and numerous household products, such as, some paints, coatings and cosmetics. However, motor homes are much smaller than your home and therefore the exchange of air inside a motor home is significantly less than a home. These products, when new or when exposed to elevated temperatures and/or humidity, may "off-gas" different chemicals, including formaldehyde. This off-gassing, in combination with the minimal air exchange, may cause you to experience irritation of the eyes, nose, and throat and sometimes headache, nausea, and a variety of asthma-like symptoms. Elderly persons and young children, as well as anyone with a history of asthma, allergies, or lung problems, may be more susceptible to the effects of off-gassing.

Formaldehyde

Most of the attention regarding chemical off-gassing surrounds formaldehyde. Formaldehyde is a naturally occurring substance. It is also a key industrial chemical used in the manufacture of the numerous consumer products which we referred to above and used in the construction of motor homes. Trace levels of formaldehyde are also released from smoking, cooking, use of soaps and detergents such as carpet shampoos, cosmetics, and many other household products. Some people are very sensitive to formaldehyde while others may not have any reaction to the same levels of formaldehyde. Amounts released decrease over time.

Ventilation

To reduce or lessen exposure to chemicals from off-gassing it is of utmost importance that you ventilate your motor home. Ventilation should occur frequently after purchase and at times when the temperatures and humidity are elevated. Remember off-gassing is accelerated by heat and humidity. Open windows, exhaust vents, and doors. Operate ceiling and/or other fans, roof air conditioners, and furnaces and use a fan to force stale air out and bring fresh air in. Decreasing the flow of air by sealing the motor home increases the formaldehyde level in the indoor air. Please also follow the recommendations contained in "Care AND Maintenance" section regarding tips to avoid condensation problems.

-  **Note:** We recommend that you do not smoke inside your motor home. In addition to causing damage to your motor home, tobacco smoke releases formaldehyde and other toxic chemicals.
-  **Note:** If you have any questions regarding the health effects of formaldehyde, please consult your doctor or local health department.
-  **Note:** Chemical off-gassing is not a defect in your motor home and is not covered by the Limited Warranty. Please follow the recommendation in this section to address this concern.

SEAT BELTS

⚠ WARNING Do not occupy beds or any other seats that are not equipped with safety seat belts while the motor home is in motion. Do not use a seat belt on more than one person.

Pilot and co-pilot seats must be locked in a forward facing position with seat belts fastened while the motor home is in motion. Avoid seat rotation while in transit.

The sleeping accommodations in this vehicle are designed for occupancy only while the vehicle is parked. All occupants in this vehicle must be seated at a designated seating position and must wear seat belts at all times while this vehicle is in motion.

Safety belts and seats can become hot in a vehicle that has been closed up in sunny weather; they could burn a small child. Check seat covers and buckles before you place a child anywhere near them.

Seat Belt Operation

All occupants must be furnished with and use seat belts while the motor home is moving. However, it is not intended for all seats to be simultaneously occupied while the vehicle is in motion without regard to the total loaded weight of the vehicle. Insert the belt tongue into the proper buckle (the buckle closest to the direction the tongue is coming from) until you hear a snap and feel it latch. Make sure the tongue is securely fastened in the buckle. Adjust the belt to the proper position; snug and as low as possible around the hips, not around the waist. To unfasten, push the release button and remove the tongue from the buckle.

Maintenance

⚠ WARNING FAILURE TO INSPECT AND IF NECESSARY REPLACE THE SAFETY BELT UNDER THE ABOVE CONDITIONS COULD RESULT IN SEVERE PERSONAL INJURIES IN THE EVENT OF A COLLISION.

Inspect the safety belts periodically to make sure they work properly and are not damaged. Inspect the safety belts to make sure there are no nicks, tear or cuts. Replace if necessary. A qualified service technician should inspect all safety belt assemblies after a collision. Four Winds International recommends that all safety belt assemblies used in vehicles involved in a collision be replaced.

Child Restraints

If your child requires a child safety restraint system (seat), Four Winds recommends installing the child safety seat in the forward facing booth dinette position. For rear-facing child seats and infant carriers, the dinette table can be placed in the "down" position to allow adequate room for the rear facing child seat. If your motor home is not equipped with a forward facing booth dinette seat, we recommend that small children that require a child seat not be transported in a motor home. Please Note:

- Rear-facing child seats or infant carriers should never be placed in the front seats.
- Never let a passenger hold a child on his or her lap while the vehicle is moving.
- You are required by law to use safety restraints for children in the U.S. and Canada. If small children (generally children who are four years old or younger and who weigh 18 kg [40 lbs] or less) ride in your vehicle, you must put them in safety seats made especially for children.

 **Note:** Check your local and state or provincial laws for specific requirements regarding the safety of children in your vehicle.

 **Note:** Always follow the instructions and warnings that come with any infant or child restraint you might use.

If the child is the proper size, restrain the child in a safety seat. Children who are too large for child safety seats (as specified by your child safety seat manufacturer) should always wear safety belts.

If the shoulder belt portion of a combination lap and shoulder belt can be positioned so it does not cross or rest in front of the child's face or neck, the child should wear the lap and shoulder belt.

Never use pillows, books, or other objects to boost a child.

EGRESS WINDOW

An egress window is designated for use as an exit in the case of an emergency. Inside the motor home the egress window is easily identified by the red locking handles. There are two common styles of latches, determine the style of locking handle you have and refer to the following illustrations for operation. It is also marked as an "EXIT". The glass slider in the egress window operates the same as all other windows;

TEST: The egress window should be opened twice a year to ensure proper operation. Over time, the rubber seal will tend to stick to the egress window. Occasional operation will help prevent the rubber seal from sticking.

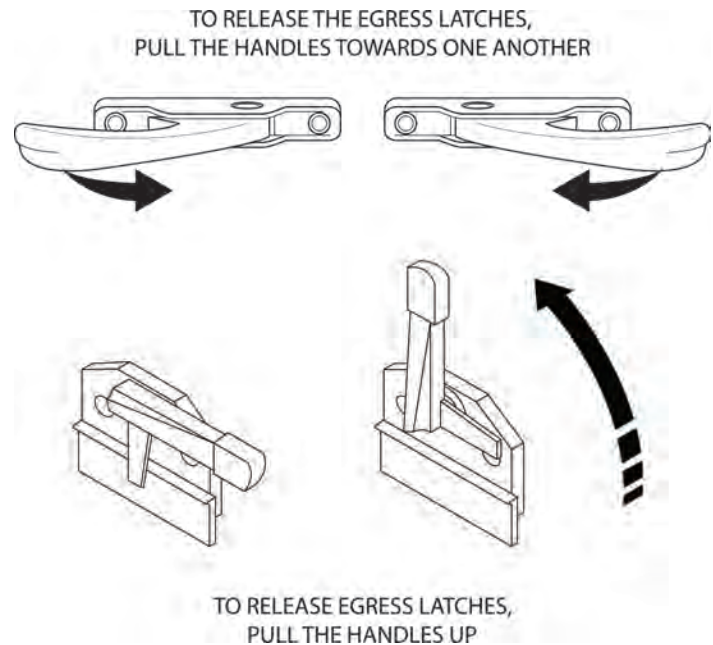

TRAILER TOWING

⚠ WARNING A separate functioning brake system is required for any towed vehicles or trailers weighing more than 1000 lbs when fully loaded. NEVER exceed the GVWR, or the GAWR specified on the motor home certification label. Also NEVER exceed the weight ratings of the trailer hitch installed on the motor home. Failure to heed any part of this warning could result in loss of control of the motor home and towed vehicle or trailer and may cause an accident and serious injury. For specific towed vehicle braking requirements, consult the chassis owners manual.

⚠ WARNING The motor home fully loaded and the trailer, or towed vehicle, must not exceed the motor home chassis' Gross Combination Weight Rating (GCWR). Consult with your selling dealer to determine the GCWR of the motor home. Do not exceed the motor home Gross Combined Weight Rating (GCWR) or the hitch rating. The tongue weight, the weight pushing down on the hitch, must not exceed 10% of the hitch capacity.

Always use safety chains between the motor home and the towed trailer or vehicle. Cross chains under the trailer tongue and allow slack for turning corners. Connect safety chains to the trailer or vehicle frame or hook retainers. Never attach chains to the bumper of a vehicle.

Tow bars or car dollies generally are made to travel in a forward direction only. Most towing equipment of this type is not designed for backing. Never attempt short back up distances with a tow bar or tow dolly. Damage to the motor home, towed vehicle or towing device will result.

📖 Note: Four Winds International accepts no responsibility for damage to the chassis and other components resulting from towing loads greater than its designated class specifications. Also consider the gross combined weight rating of the motor home before towing a trailer or vehicle. Towing an object such as a boat and trailer or a vehicle behind the motor home results in added driving considerations that you must contend with.

CHASSIS

 **Note:** All issues regarding the chassis warranty, parts and service should be directed to the chassis manufacturer.

The following section is for reference only. For detailed information regarding product information and proper maintenance of the chassis, refer to the chassis manufacturer's owner's manual.

You as the owner are responsible for taking the proper precautions when attempting any repair or maintenance. If you are not sure what action to take, or uncomfortable with performing a maintenance or repair function, contact your dealer, or a designated chassis manufacturer servicing dealer. Check information supplied by chassis manufacturer for a service dealer near you.

Special procedures or schedules for "breaking-in" your new motor home are minimal. Make sure to follow the recommendations as outlined in the chassis owner's manual to ensure proper future performance and economy.

 **Note:** Make sure to read all chassis information supplied by the chassis manufacturer, paying particular attention to precautionary notes and warnings, as well as all maintenance procedures and schedules.

EMERGENCY STOPPING

IF AN EMERGENCY EVER REQUIRES YOU TO BE STOPPED, BE SURE TO FOLLOW THESE GUIDELINES:

1. Pull off the road as far as possible.
2. Select the Park position on a gas motor home and the neutral position on a diesel motor home on the shift selector and apply the Parking Brake.
3. Turn on the hazard warning flashers.
4. Use three red warning indicators such as flares, reflectors, or lanterns as required by the Uniform Vehicle Code and Model Traffic Ordinance as follows:
 - a. Place the first indicator on the traffic side of the vehicle, directed at the nearest approaching traffic.
 - b. Place the second 100 feet behind the motor home in the center of the lane and toward approaching traffic.
 - c. Place the third 100 feet in front of the motor home in the center of the lane and away from the traffic approaching from behind.
5. Always stand off the road.

 **Note:** Curves and/or hills may effect the safe placement of warning indicators.

ENGINE AND DRIVE TRAIN

Full operating and service information may be obtained by consulting the engine and drive train operating and service manuals provided by the chassis manufacturer. For maximum engine efficiency and long service life, always follow recommendations, as outlined by the chassis manufacturer. Regular visual inspections can help detect minor adjustments and needed maintenance. All other components of the chassis should be inspected regularly per the schedules set by the chassis manufacturer.

Engine Access - Gas **GAS ONLY**

⚠ WARNING If the engine cover is not seated correctly, exhaust gases may leak into the motor home, creating a dangerous and potentially lethal situation.

The motor home engine can be accessed for service from inside the motor home. The engine cover between the driver and passenger seats can be removed.

When reinstalling the engine cover, make sure that it is seated correctly without obstruction from carpet, floor mats, etc.

Engine Access - Diesel **DIESEL ONLY**

The engine fluid level checks which are located at the exterior rear of the motor home, can be accessed by lifting the top half of the engine grate. For service personnel, additional access areas are located in the bedroom. The first location is in the wardrobe closet on the floor, remove the four screws to remove the access panel. The second access panel is located on the bedroom floor between the bed and the wardrobe closet. Remove the four mounting screws to remove the access panel.

FUELING THE MOTOR HOME

Be extremely careful when fueling the motor home. Always shut off the engine, do not smoke, or use cellular phones and shut off all pilot lights before adding fuel. Fuel spills represent a serious fire hazard, and should be cleaned up immediately. Never restart the engine, or relight pilot lights while raw fuel is present. When weather gets cold or the motor home has not been used for a while, a fuel anti-gel additive will be needed.

For your convenience there may be two fuel fills on the motor home. If so equipped, they are located on both sides of the motor home, towards the front of the unit. This allows access into filling stations from either side of the motor home.

 **Note:** If you should lose your fuel cap, it should be replaced as soon as possible, with a cap of the same type.

 **Note:** Always remove the fuel cap slowly and pay close attention to the fuel recommendations outlined in the chassis literature.

Ford Fuel Pump Collision Shut-off Switch

If your motor home is involved in a collision, it is possible that an inertia switch in the fuel pump circuit will open, shutting down the flow of fuel to the engine. This is a safety feature designed to help keep raw fuel from spilling out and creating additional danger. When this inertia switch has been tripped, it is necessary to manually reset it before the motor home can be restarted and moved. Review your chassis owner's manual for the location of the switch and instructions for resetting.

TRAVEL PREPARATION

Chassis Checks

Like any vacation trip, pre-planning will pay big dividends. In addition to routine trip preparations such as having newspaper delivery stopped and mail held at the post office, there are now more vehicle-related preparations than there are with an automobile.

- Fluid levels (oil, power steering, radiator, transmission, windshield washer, etc.)
- Belts (tension and condition)
- Battery (electrolyte level if applicable, connections, charge)
- Hoses (clamps tight, condition, leakage)
- Seals, gaskets (leaks)

 **Note:** Refer to the Chassis Manufacturer's Owner's Manual for more information.

Exterior Checks

- Tire pressure/condition and lug nut torque
- Headlights, running and safety marker lights including brake and turn signal and also any trailer light connections
- Security of any auxiliary equipment such as TV and awning, etc.
- Windshield wiper blades
- Generator compartment
- Fresh and waste water connections/drains and supplies such as high pressure hose
- Propane compartment/tank

Undercarriage Checks

- Brakes, including lines, pads/shoes, seals
- Engine area for pan gasket or other leaks
- Anything unusual hanging or tangled with road debris such as tree limbs
- Tank condition (gas, fresh water, waste water)

Operational Checks

- Check operation of all systems, including: Wipers, windshield, horn, brakes, steering, transmission, heater, defroster, air conditioner, and seat adjustment.
- Also idle engine long enough to check cooling system and alternator operation. Be sure to turn on headlights and climate controls to see if alternator handles the additional drain on the electrical system (should not show discharge).

 **Note:** Refer to the Chassis Manufacturer's Owner's Manual for more information.

Pre-Trip Checklist

Pay careful attention to where and what type of flammable materials you store. Certain storage areas are clearly labeled **DO NOT STORE COMBUSTIBLE MATERIALS**. Examples of spark producing areas, depending on the motor home model, are: base kitchen cabinets, front dinette base, exterior refrigerator service compartment, as well as refrigerator cabinet. Please use discretion as to what potentially dangerous products your motor home contains while traveling. Be sure all canisters and bottle tops are secure and leak free.

The following checklist will assist your preparing the living quarters for a trip

- In winter make sure that the fresh water tank system is freeze protected.
- Make sure that all storage items are secured and that heavy items are stored low so they don't fall.
- Check operation of stove and refrigerator.
- Check that you have proper paperwork such as owners registration card, vehicle registration, proof of insurance, and valid driver's license.
- When preparing for your trip, always consider vehicle weight when loading the motor home.

CONTROLS AND OPERATIONS

DASH CONTROLS - GAS **GAS ONLY**

IMPORTANT: The dash controls and instrument panels provided within the motor home are installed by either the chassis manufacturer or Four Winds International and may not appear exactly as pictured. For items not described within this manual, refer to the chassis manufacturer's operations manual.

 **Note:** The appearance or placement of the gauges, instruments and controls may not exactly match the illustrations within the chassis manufacturer's operations manual however, the instructions for their use will still apply.

Mirror Control Button

Used to adjust outside mirrors for visibility. Push the side selector left to adjust the roadside exterior mirror, or right to adjust the curb side exterior mirror. Always adjust mirrors for proper vision before starting and moving the motor home.

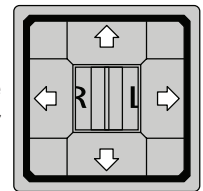

Mirror Heat

Activates heating element to defrost the outside rearview mirrors.

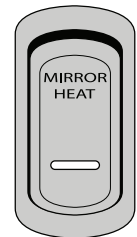

Fog Lights

The fog lights switch controls the on/off operation of the fog lights.

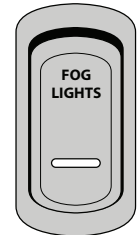

Emergency Start

Holding this switch down while turning the ignition switch will allow the auxiliary "house" battery(s) to be used to start the engine in the event the automotive battery is low or dead. This feature is designed to be used momentarily to start the engine. **DO NOT** hold the switch down for extended periods of time.

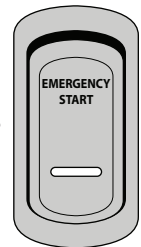

Generator Remote Start

Controls the remote **ON/OFF** operation of the generator. Refer to the manufacturer's operation manual. Depress and hold the top of the switch to start the generator. Depress the bottom of the switch to stop the generator. Depress and hold the bottom of the switch to prime the generator prior to starting.

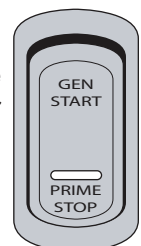

 **Note:** Refer to the generator operations manual for detailed information regarding the proper usage, and service procedure for the generator.

Windshield Fans

CAUTION DO NOT REMOVE THE PROTECTIVE CAGE FROM THE FAN. DO NOT PLACE FINGERS OR OTHER OBJECTS INTO THE PROTECTIVE CAGE.

The fan switch turn the power ON or OFF to the overhead defroster fans. Each fan can be operated separately with individual switches on the dash, if this switch is in the OFF/HIGH/LOW position. The purpose of the windshield fan is to aid in defrosting the windshield. Turning the fans toward the cockpit area may cause visibility issues and may also come in contact with other overhead components.

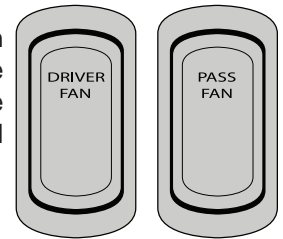

DASH CONTROLS AND INSTRUMENT PANELS - DIESEL **DIESEL ONLY**

Transmission Control Push Button Shift Selector

IMPORTANT: The Chassis Owner's Manual furnished with the motor home has complete information for operating and maintaining the chassis functions. The appearance of the gauges may not match the diagrams but is intended for reference.

Operation:

1. Start the engine.
2. Use Reverse (R) to back the vehicle. Completely stop the vehicle before shifting from a forward gear to Reverse (R) or from Reverse (R) to a forward gear. There is only one Reverse (R) gear.
3. Select Drive (D) for all normal driving conditions. The vehicle will start out in First (1) gear, and as speed increases, the transmission will upshift through each gear automatically. As the vehicle slows down, the transmission will downshift to the correct gear automatically. The pressure of your foot on the accelerator pedal influences the automatic shifting. When the pedal is fully depressed, the transmission will automatically upshift near the governed speed of the engine. A partially depressed position of the pedal will cause the upshifts to occur at a lower engine speed.
4. Occasionally the road, load, or traffic conditions make it desirable to restrict the automatic shifting to a lower range. The lower the gear range, the greater the engine braking power. Use the up or down arrow buttons on the shift selector to reach the desired gear.
5. Use Neutral (N) and apply the parking brake when the vehicle is parked with the engine running.

 **Note:** See the Allison Transmission Owner's Manual for more information on 3000 and 4000 MH transmission operation.

 **Note:** In the lower gear ranges, the transmission will not upshift above the highest gear selected unless the engine governed speed is exceeded.

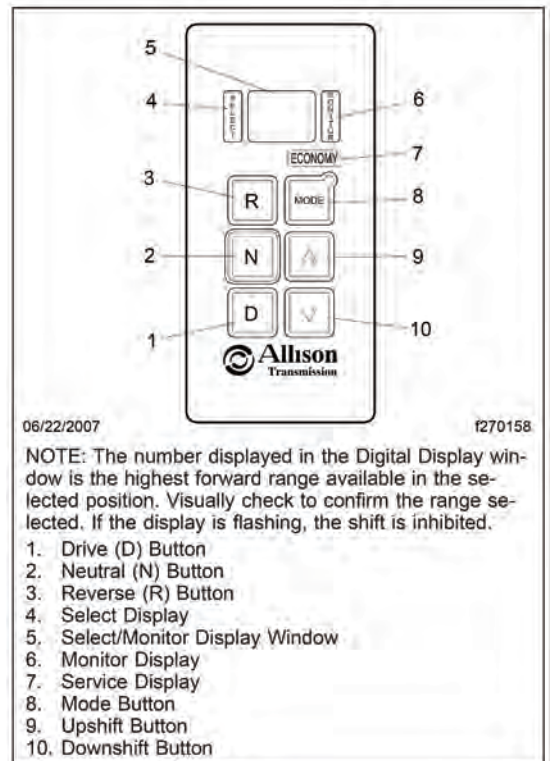

Keypad Push Button Shift Selector

The Allison keypad push button shift selector has six buttons on the keypad that cause the following transmission operations to occur:

- **R:** Press to select reverse
- **N:** Press to select neutral
- **D:** Press to select Drive
- **↑(Upshift) Arrow:** Press to select the next higher forward range
- **↓(Downshift) Arrow:** Press to select the next lower forward range
- **MODE:** Multi-functional use.

The **↑(Upshift) Arrow** and **↓(Downshift) Arrow** are only functional while in a forward range, and not in N (Neutral) or R (Reverse).

Freightliner Only Information Message Center

The diagram shows 16 numbered icons arranged in two rows. Row 1 contains icons 1 through 8. Row 2 contains icons 9 through 16. Icon 4 is a rectangular box. Icon 5 is labeled 'BRAKE'. Icon 13 is labeled 'BRAKE'. The date '09/23/2009' is at the bottom left and 'f611067' is at the bottom right.

1. Check Engine Indicator	6. Check Transmission Indicator	11. Shift Inhibit Indicator
2. High Exhaust System Temperature (HEST) Lamp	7. Engine Brake Engaged Indicator	12. Headlight High-Beam Indicator
3. Stop Engine Warning	8. Cruise On Indicator	13. Parking Brake Indicator
4. Dash Driver Display Screen	9. Left-Turn Signal Arrow	14. Low Air Pressure Indicator
5. ABS Indicator	10. Diesel Particulate Filter (DPF) Lamp	15. Wait to Start Indicator
		16. Right-Turn Signal Arrow

Freightliner ONLY Information Message Center

SHIFTER PANEL SWITCHES

Mirror Control Button

Used to adjust outside mirrors for visibility. Push the side selector left to adjust the roadside exterior mirror, or right to adjust the curb side exterior mirror. Always adjust mirrors for proper vision before starting and moving the motor home.

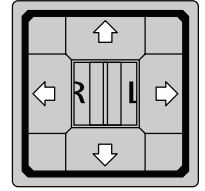

Mirror Heat

Activates heating element to defrost the outside rearview mirrors.

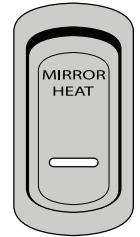

Engine Brake

Enables or disables the engine braking aid. Refer to the Chassis Owner's Manual for detailed information.

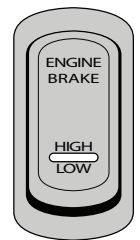

Air Horn

Activates air horn system (press horn pad on steering wheel to sound air horn). When switch is in the off position, only the chassis supplied horn will sound. When switch is in the on position, both the chassis and air horn will sound.



Sun Visor

Raises or lowers the driver side visor. The visor is equipped with a dual range motor for driving safety. When the ignition switch is ON, the visor will only travel a predetermined distance which does not impede the driver's field of vision. When the ignition switch is in the OFF position, the visor will fully extend.

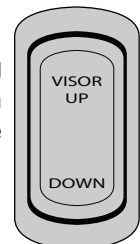

Privacy Shade

Raises or lowers the privacy shade. The shade is equipped with a dual range motor for driving safety. When the ignition switch is ON, the shade will only travel a predetermined distance which does not impede the driver's field of vision. When the ignition switch is in the OFF position, the shade will fully extend.

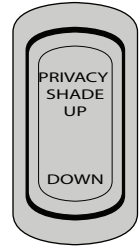

Tag Dump (Tag Axle Only)

Dumps air from the tag axle to lower or raise the axle during travel. Refer to Chassis Manual for further instructions.

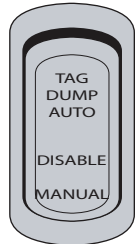

Windshield Fans

CAUTION DO NOT REMOVE THE PROTECTIVE CAGE FROM THE FAN. DO NOT PLACE FINGERS OR OTHER OBJECTS INTO THE PROTECTIVE CAGE.

The fan switch turn the power ON or OFF to the overhead defroster fans. Each fan can be operated separately with individual switches on the dash, if this switch is in the OFF/HIGH/LOW position. The purpose of the windshield fan is to aid in defrosting the windshield. Turning the fans toward the cockpit area may cause visibility issues and may also come in contact with other overhead components.

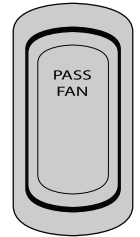
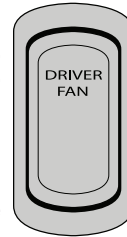

Pedals

Adjust the brake and accelerator pedals forward and rearward for driver comfort.

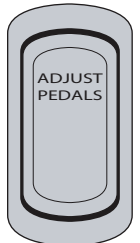

DASH PANEL SWITCHES

Block Heat

Activates the motor home engine block heater (for use in cold weather). The block heater operates on 120 Volt AC provided by the generator or shore power.

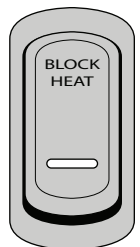

Docking Lights

Switches side docking lights on or off which are located on the rear wheel wells.

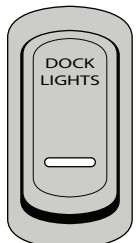

Battery Boost

Temporarily connects the coach and chassis batteries if either bank of batteries goes dead for some reason. This feature is designed to be used momentarily to start the engine. DO NOT hold the switch down for extended periods of time, overheating will occur causing serious electrical failure and damage to electrical components.

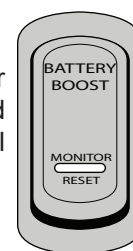

Light Control Knob

The control knob for the headlights, side marker lights, taillights, parking lights, license plate lights, fog lights and panel lights is located on the instrument panel. Control knob positions are as follows:

1. OFF: All exterior lights are off.
2. PARK LIGHTS: All exterior lights, excluding the headlights are illuminated.
3. HEADLIGHTS: All exterior lights are illuminated.
4. FOG LIGHTS: Headlights must be illuminated, then pull the control knob out to illuminate the fog lights.

Panel Light Dimmer Control Wheel

To increase or decrease the level of light intensity for the dash panel, rotate the control wheel up to increase, or down to decrease.

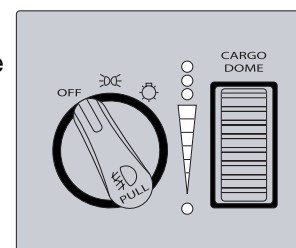

PASSENGER ARMREST SWITCHES

Porch Light

Controls the exterior light on the door side of the motor home.

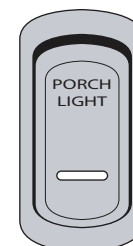

Step Light

Controls the entry step courtesy lighting.

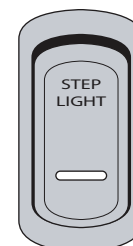

Step Cover

Extends and retracts the entry step well cover.

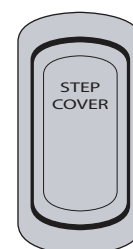

Main Awning

Extends or retracts the main patio awning.

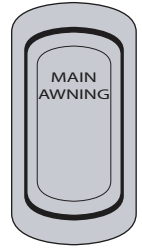

Door Awning

Extends or retracts the entry door awning.



Ceiling Light

Controls the front ceiling lights. Combined with 3-way switch in hallway. Can be operated from either switch.

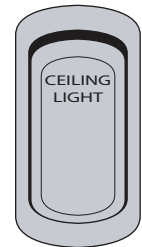

STEERING WHEEL ADJUSTMENT

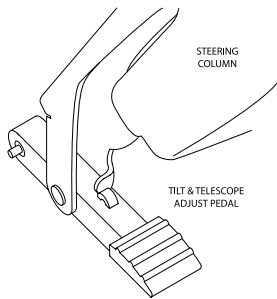

Tilt

To tilt the steering wheel, depress the adjustment pedal (located at the base of the steering column) and move the steering wheel to where you want it. Release the pedal and the steering wheel will lock in the new position.

Telescope

To telescope the steering wheel, depress the adjustment pedal (located at the base of the steering column) and move the steering wheel up or down. When the desired position is obtained, release the pedal and the steering wheel will lock in the new position.

TURN SIGNAL/LANE CHANGE/HIGH-LOW BEAM/HAZARDS LEVER

The lever on the left side of the steering column controls the turn signal with lane change feature, as well as the Head lamp high/low beam toggle and the Hazard Lights.

The turn signal lever has two off-center positions, one positions upward (for right) and one downward (for left). To signal a turn, move the lever all the way up or down. These are latching positions. The lever will stay in one of these positions until the steering wheel returns back to center (off) as the turn is completed.

To change the head lamps from low to high beams, pull the same lever used for turn signal operation up toward the driver and release the lever. This is a self-returning action. Repeating this toggle action will return to the low beams.

To engage the hazard lights, pull the red hazard switch out away from the steering column. This will activate the hazard light flash sequence. To disengage the sequence raise or lower the turn signal lever to a latching position, then manually return the lever back to center (as if signaling a lane change).

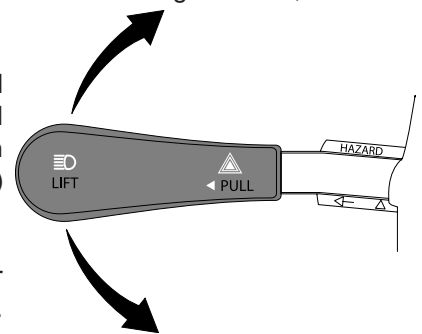

SMART STEERING WHEEL

Functions on the Steering Wheel are either momentary or latching. The HORN, HEAD LAMP FLASH, CRUISE CANCEL, CRUISE RESUME, CRUISE SET, MARKER LAMP FLASH, and WIPER WASH switches operate in the momentary mode and only operated while the switch is pressed.

The CRUISE ON/OFF, WIPER OFF, WIPER HI/LO, and WIPER VARIABLE switches operate in the latching mode and remain actuated until the corresponding CRUISE OFF, or WIPER OFF switch is pressed or the Ignition input on the Master is turned off. The WIPER HI/LO switch has the additional feature that initially when the switch is pressed the wipers operate in the low speed mode and additional operations of the switch cause the wipers to alternate from the high to low speed modes.

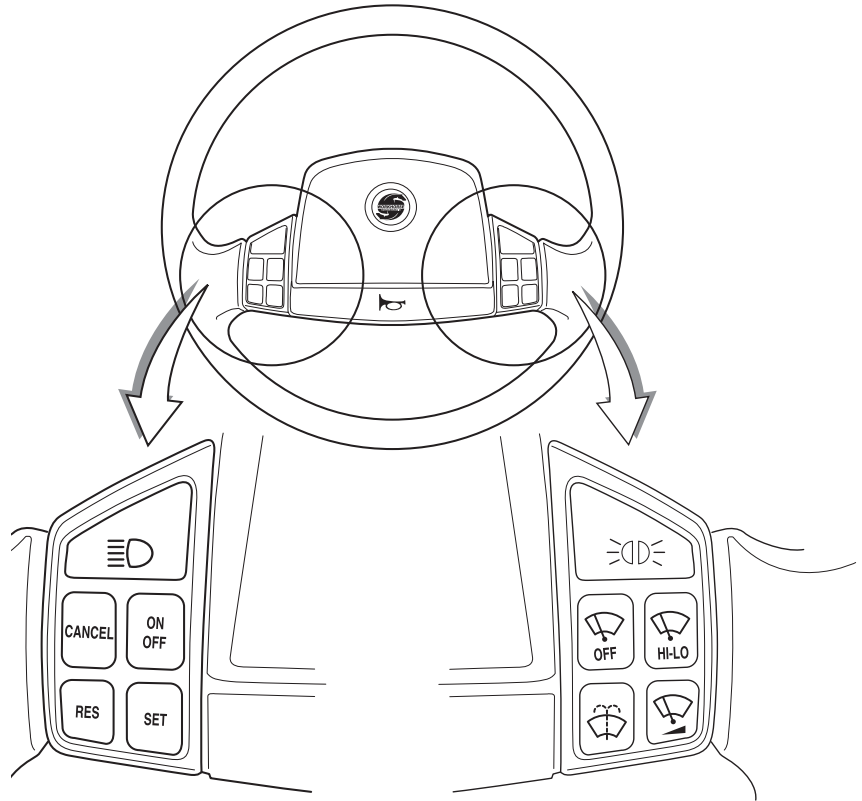

HORN - The horn switch function on the steering wheel is accomplished using a bar located below the center of the wheel.

HEAD LAMP FLASH - When the head lamps are turned on, pressing this switch will cause them to go off. In like manner, if the head lamps are turned off, pressing the switch will cause them to go on.

MARKER LAMP FLASH - If the marker lamps are turned on, pressing the switch will cause them to go off. In like manner, if the marker lamps are turned off, pressing the switch will cause them to go on.

CRUISE FUNCTIONS:

CRUISE ON - Operation of this switch activates the Cruise On/Off switch to the "on" state.

CRUISE OFF - Operation of this switch activates the Cruise On/Off switch to the "off" state.

CRUISE SET - Operation of this switch sets the Cruise control at the speed you are currently traveling.

CRUISE RESUME - If you recently interrupted the cruise control by hitting the brake or clutch pedal, hitting the Resume button will command the car to accelerate back to the most previous speed setting.

CRUISE CANCEL - Operation of this switch will allow you to slow down by turning off the Cruise Control with the cancel button.

WIPER FUNCTIONS:

WIPER WASH - Operation of this switch activates the wash pump.

WIPER LO/HI - Operation of this switch causes the wiper to operate at either low or high speed.

WIPER VARIABLE - In light rain or mist conditions press the switch once when the windshield first needs clearing. When the windshield again requires clearing press the button again - setting the time period between subsequent wipes to that required by current conditions.

WIPER OFF - Operation of this switch causes all operation of the wipers to be canceled.

HEAD LAMPS ON WITH WIPERS - Activation of any wiper function generates a "Head lamps On" function in the Master that will only be reset by turning off the ignition or by activating then deactivating the dashboard head lamp switch.

SPOTLIGHT

The spotlight mounted on top of the motor home can be controlled by using the included remote. Using the remote control, turn on the light using the ON/OFF switch. With the four way switch on the remote control, adjust your light to the desired location. Depending upon conditions, the remote may be used up to 150 feet from the spotlight. The speed of the light rotation can be controlled by depressing the +/- button one time and by depressing it again to restore the original speed.

The spotlight runs on 12 Volt DC power, which is supplied by the house batteries. Be aware of the house battery charge, do not drain the batteries by accidentally leaving the spotlight ON.

Programming The Transmitter:

1. Disconnect power to the spotlight by turning the ignition key "on". Power is removed from spotlight when the key is on for safety.
2. Remove the battery cover from the back of the remote.
3. Set the 7 dip switches to a selection of your choice. There are 3 positions on each; positive, negative, and neutral. Use a small screwdriver and select a position for each dip switch.
4. Insert both MN21 batteries with the +/- in the same direction. Be sure batteries have adequate charge.
5. Replace the battery cover.
 - a. Depress the ON/OFF button and hold it down. The red LED will illuminate.
 - b. While holding the ON/OFF button down, turn the ignition off.
 - c. Keep your finger on the ON/OFF button. In a few seconds the light bulb will flash. This will tell you the process is finished.

BULB REPLACEMENT: The spotlight utilizes a Cr5 Pentabeam bulb, which may be purchased through Golight, Inc. 308-278-3131 or 800-557-0098.

REAR VISION SYSTEM

This system gives a televised view of what is behind the motor home. It is used as an aid in backing the motor home, and can also be used for greater field of vision when driving in heavy traffic. Picture is representation only. Actual system may look different than that pictured.

Make sure to check the mirrors when driving and backing, for a more complete field of vision. The camera is equipped with a wide angle lens that can initially present an image that may be deceiving. Make sure to practice backing in a safe place, using the monitor to become accustom to it's operation.

Rear Vision Systems vary within our motor homes. The Class C motor home (except for Sprinters) come equipped with a dash radio with a motorized video screen that pops up and displays the back up camera image.

Listed below are a few of the basic commands used. Please consult your Rear Vision system manual for detailed operating instructions

1. **POWER ON/OFF:** Press once turns unit ON. Press again for OFF.
2. **SELECT:** Pressing button sequences source input modes from CH1 TO CH3.
3. **DAY/NIGHT:** Pressing button sequenced day/night back light.
4. **MENU:** Pressing button gives access to an on screen display menu and the setup menu.
5. **VOLUME:** Pressing button decreases or increases speaker volume.

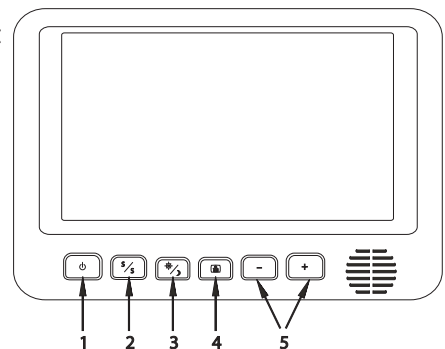

⚠ DANGER Make sure to check the mirrors when driving and backing, for a more complete field of vision. The camera is equipped with a wide angle lens that can initially present an image that may be deceiving. Make sure to practice backing in a safe place, using the monitor to become accustomed to its operation.

Camera Operation

Power Switch:

The power button has two settings, Stand-by and ON. When in the stand-by mode the monitor operates when the recreation vehicle transmission is switched into Reverse. When in the ON mode the monitor system operates when the ignition switch is in the ON position.

 **Note:** The unit will not turn ON when the hazard lights are activated.

CA SEL (Camera Select Button):

This button is used with the optional side view camera system. Use the button to toggle through the multiple camera views.

Day/Night Mode Button:

Pre-set brightness and contrast levels optimized for day or night operation.

Contrast & Brightness:

Variable controls of contrast and brightness. Should be adjusted if the DAY/NIGHT switch does not achieve the most desirable picture.

Volume:

Variable control of internal speaker volume.

DASH RADIO

The dash radio will control the multi-functions for the dash audio system. Basic Operations are listed below. For complete information, consult your owner's manual provided. Satellite-Ready means that the in-dash radio will work with a satellite radio tuner. The satellite tuner and antenna are standard on the Montecito only and must be purchased separately for other motor homes.

POWER ON / OFF:

Press any button (except the eject button ▲ (23) to turn the unit ON. Press the Volume On /Off button (1) to turn the unit OFF.

VOLUME CONTROL:

To increase the volume, rotate the volume control (1) clockwise. To decrease the volume, rotate the volume control counter clockwise.

MUTE:

Press the MUTE button (26) on the control panel to mute the audio output. Mute will appear on the LCD display. Press MUTE again to restore the audio output to the previous level.

MODE:

Press the MODE button (4) on the control panel to select a different mode of operation, as indicated on the display panel. Available modes include TUNER, CD, SIRIUS, IPOD, CDC and AUX IN (optional Auxiliary Input).

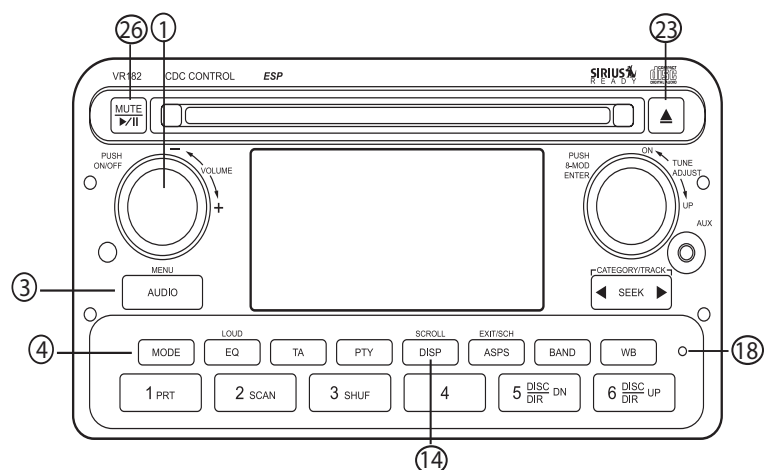

 **Note:** CDC, IPOD or SIRIUS mode will be skipped if the module is not installed.

ADJUSTING THE CLOCK (DISP): The current time is displayed in the lower right hand corner of the LCD display. To adjust the clock:

1. Press the DISP button (14) until the hour flashes in the LCD.
2. Rotate the VOLUME control (1) within 5 seconds to adjust the hours.
3. Press the DISP button again and the minutes will flash.
4. Rotate the VOLUME control within 5 seconds to adjust the minutes.
5. Press the DISP again to exit time set mode. After 5 seconds, time set mode will exit automatically.

 **Note:** If the time mode is set to 12 HOUR in the setup menu, continue turning the VOLUME control to change between AM (A) and PM (P).

 **Note:** If P-CLOCK ON is selected in the setup menu, the clock will be displayed in the center of the LCD in large characters when the unit is turned off while the ACC. is on.

RESET:

Use a ball point pen or thin metal object to press the RESET button (18). The unit will return to the factory default settings. The reset button should be activated for the following reasons: Function buttons do not operate, or error symbol is on the display. To recover factory default settings, press and hold the MODE button (4) for more than 3 seconds. The LCD will display EEP- INIT and all settings will return to the original factory values.

AUDIO MENU:

Press the AUDIO / MENU button (3) on the control panel to access the Audio Menu.

You can navigate through the Audio Menu items by pressing the AUDIO / MENU button repeatedly. Once the desired menu item appears on the display, adjust that option by turning the VOLUME control (1) within 5 seconds. The unit will automatically exit the Audio Menu after 5 seconds of inactivity. The following menu items can be adjusted:

BASE LEVEL:

Use the volume control to adjust the Base from -6 to +6.

TREBLE LEVEL:

Use the volume control to adjust the Treble level range from -6 to +6.

BALANCE:

Use the volume control to adjust the Balance between the left and right speakers from 12L (full left) to 12F (full front).

FADER: Use the volume control to adjust the Fader between the rear and front speakers from 12L (full left) to 12F (full front).

VOLUME LEVEL: Use the volume control to adjust the volume level from 0 to 46.

ECLIPSE GPS NAVIGATION SYSTEM

OPTION DIESEL **DIESEL ONLY**

⚠ WARNING Always operate the vehicle in a safe manner. Do not be distracted by the navigation system while driving. Failure to do so could result in an accident or collision, resulting in death or injury.

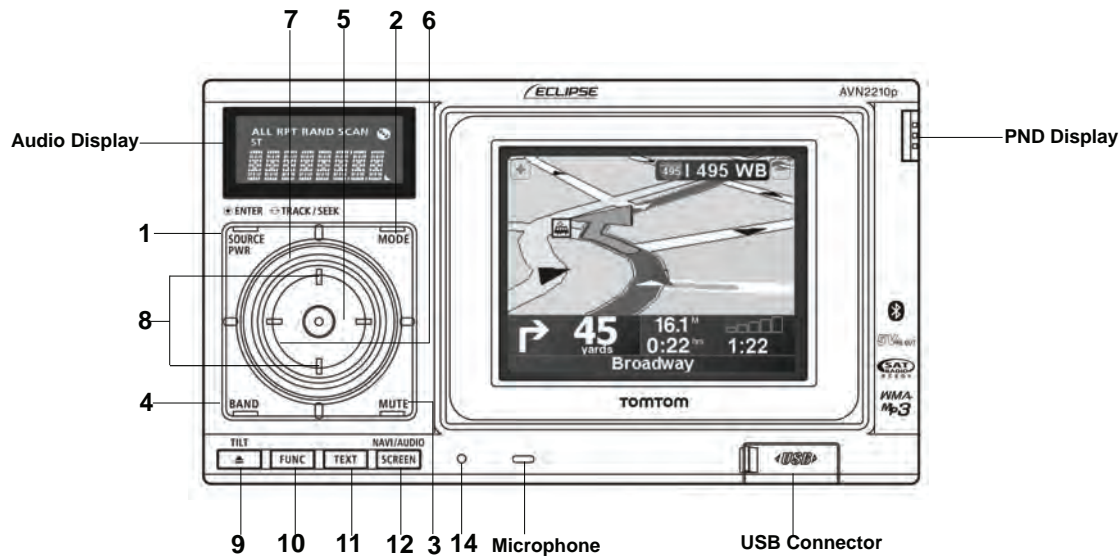

1. **[Source/pwr] Button** - Brief pressing switches the items in the audio mode. Pressing more than one second turns the audio mode OFF. Pressing more than 5 seconds turns the power completely OFF.
2. **[MODE] Button** - Brief pressing switches to the preset channel select mode or CD track select mode.
3. **[MUTE] Button** - Activates and deactivates mute.
4. **[BAND] Button** - Switches radio bands.
5. **[ENTER] Button** - Enters selected item.
6. **[SELECT Right/Left] Button** - Selecting radio station and CD tracks. Select setting items in function mode.
7. **[VOL] Rotary Knob** - Adjusts volume in preset channel select mode or track select mode, select item you want.
8. **[SELECT Upper/Lower] Button** - Selects the folder in CD {MP3/WMA} mode.
9. **[▲ OPEN/EJECT] Button** - Brief pressing ejects disc or opens/closes the front panel. Longer pressing tilts the front panel by one step at each pressing of the button.
10. **[FUNC] Button** - Brief pressing switches items in the FUNCTION mode at each pressing of the button.
11. **[TEXT] Button** - Brief pressing switches title display of Audio display.
12. **[SCREEN] Button** - Brief pressing switches PND display between navigation functions and audio functions. Longer pressing turns the PND off.
13. **[RELEASE] Button** - Detaches the right end of the PND display off.
14. **[RESET] Button** - Resets the unit.

KEYPAD KEYLESS ENTRY SYSTEM

Programming The Keyless Entry System Transmitter

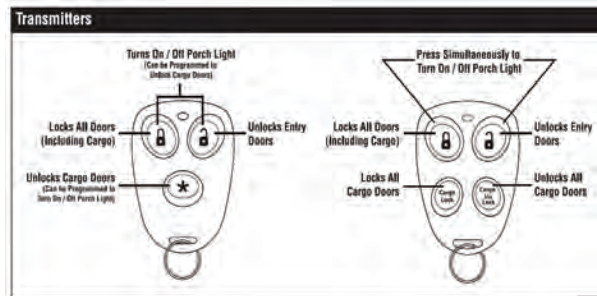
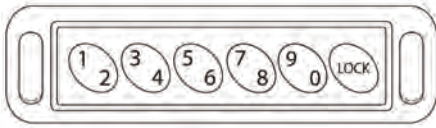

3 Button Transmitter Programming

Note: This mode will only retain the last 4 remote transmitters programmed. If the transmitter memory is exceeded, the security system will start deleting transmitters from memory in chronological order.

1. Turn the ignition to the ON position.
2. Within 15 seconds, push the Program Button located on the back of the housing 3 times. The onboard LED will be flashing and the beeper will emit a long chirp to indicate the system is in Transmitter Programming mode.
3. Press and hold any button on the transmitter until the onboard LED turns on for 2 seconds and the beeper responds with a confirming chirp, indicating the signal has been stored into memory
4. If you have additional transmitters (up to 4) that need to be programmed, repeat step 3 for each transmitter.

EXIT: Turn the ignition switch to the OFF position or leave it for 15 seconds. The onboard LED turns off and the beeper will emit 3 long chirps to confirm exit.

4 Button Transmitter Programming

Note: This mode will only retain the last 4 remote transmitters programmed. If the transmitter memory is exceeded, the security system will start deleting transmitters from memory in chronological order.

1. Turn the ignition to the ON position within 15 seconds..
2. Push the Program Button located on the back of the housing 5 times. The on-board LED will be flashing and the beeper will emit a long chirp to indicate the system is in Transmitter Programming mode.
3. Press and hold any button on the transmitter until the onboard LED turns on for 2 seconds and the beeper responds with a confirming chirp, indicating the signal has been stored into memory
4. If you have additional transmitters (up to 4) that need to be programmed, repeat step 3 for each transmitter.

EXIT: Turn the ignition switch to the OFF position or leave it for 15 seconds. The onboard LED turns off and the beeper will emit 3 long chirps to confirm exit.

Programming The Keypad Button Chirp On / Off

1. Enter the user code.
 2. Within 5 seconds, press and hold the LOCK button for three seconds.
-
- 1 Beep from the keypad = Keypad chirp ON
 - 3 Beeps from the keypad = Keypad chirp OFF

Programming The User Code

 **Note:** The default user code is "54321"

 **Note:** This mode will only retain the last 4 remote transmitters programmed. If the transmitter memory is exceeded, the security system will start deleting transmitters from memory in chronological order.

1. Enter the program code "12345" on the keypad. The beeper will emit a long chirp to confirm the correct code was entered.
2. Enter a new 4 to 6 user code on the keypad. Do not use "1234".
3. Finish by pressing the LOCK key on the keypad. 1 long beep with 2 short beeps will confirm the new user code has been stored into memory.
4. If you have additional user codes (up to 4) that need to be programmed, repeat steps 2 and 3 for each new user code.

Exit: Press and hold the LOCK key for 1 second or if 15 seconds of inactivity occurs during the above steps, the unit will revert back to the last successfully stored code. 3 long beeps confirm exit.

 **Note:** For complete operational instructions, please consult the owner's manual provided for this product.

AUTOMATIC HYDRAULIC POWER LEVELERS

 **DANGER** With any hydraulic application, holding position on a cylinder must be done with safety in mind. Failure in the system may cause the leg(s) to retract or extend on its own. When working under or near the motor home, always use jack stands of appropriate rating to support the weight of the motor home.

Read the entire operators manual and all precautions prior to operating this equipment.

Do not use the jacks to change the tires. The system is designed as a leveling and stabilizing system and is not meant to lift the motor home off the ground.

Do not operate any system functions while anyone is under the motor home.

Do not attempt to operate the system while the motor home is in motion.

Never place hands or other parts of the body near hydraulic leaks. Oil may penetrate skin causing severe injury. Wear safety glasses when inspecting or servicing the system to protect eyes from dirt, metal chips, or leaks, etc. Follow all other applicable shop safety practices.

The motor home should be parked on a fairly level surface. Ensure that there are no obstructions in the extend or retract paths of the jacks. If the surface is soft due to saturation or heat, place boards under the jacks to distribute the weight over a larger area. Using a board which measures approximately 2' wide by 2' in length is recommended. Ensure the front tires are pointing forward and not to the left or right.

 **Note:** Refer to manufacturer's operations manual before operating.

The automatic hydraulic power leveling system allows quick and easy leveling of the motor home from the driver's seat by utilizing the system touch panel. The following instructions are general operating instructions.

Automatic Leveling And Retraction Procedure

CAUTION Make sure there are no obstructions in the extend or retract paths of the jacks. Keep all people clear of the vehicle while operating the leveling system.

Do not allow excessive motion in the motor home during the Auto-Level operation. This could cause the system to level improperly.

1. **TURN ON POWER.** The power to the unit must be turned on. You need to have the ignition key in the **ON** position and the parking brake must be set to turn the control panel on. Push the **POWER** touch pad to engage power. The power touch pad should be lit when power is on.
2. **PRESS THE AUTO-LEVEL TOUCH PAD.** The system will automatically level your vehicle. The control panel will send out a series of beeps to let you know that **AUTO-LEVEL** is operating. When completed, the panel will signal a successful Auto Level. After ten minutes, the panel will enter sleep mode.
3. **RETRACTING THE JACKS.** Your Equalizer System provides you with the ability to retract the jacks using the **ALL RETRACT** feature or the **UP** touch pads for each jack. Press and release **ALL RETRACT** touch pad. All jacks will automatically retract. The jacks are retracted when all of the **LED'S** have gone out. Depending on the vehicle, full retraction may take up to 90 seconds.

 **Note:** The null, or level position has been preset at the factory. However, if you want to change the setting, or if the motor home has been dormant for more than 60 days you may need to reset the null. Refer to the automatic hydraulic levelers owner's manual for detailed information regarding the proper procedures to do this.

TURN ON POWER

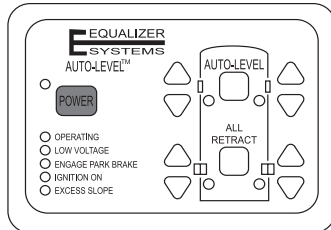

PRESS AUTO-LEVEL TOUCH PAD

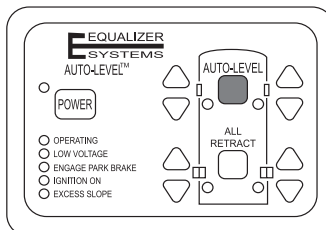

RETRACTING THE JACKS

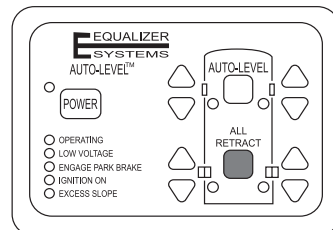

Emergency Retraction Procedure

CAUTION Following manual override operation, failure to return all valves to normal position may result in one or more jack legs drifting down from their retracted (stowed) position. For cartridge valves, rotate the center screw fully counter-clockwise.

In the event of electrical failure, the jack leg(s) may be retracted manually by following the procedure below.

Manual Override for MTE Bi-Rotational* Style Pumps (These can be identified by the presence of 2 motor solenoids and 2 motor leads)

1. The individual cartridge valves are clustered together on the side of the pump manifold. (They are labeled 1 thru 4) Locate the screws on the appropriate cartridge valve(s). Using a small flat blade screwdriver, turn the screw(s) clockwise until all the way in.

Note: The normal operating position of the screw in the cartridge valve is the counter-clockwise 'out' position. The only time the valve should be shifted manually is when attempting to operate jack(s) via manual override.

2. Remove the black plastic cap from the top of the motor. Use a small flat head screwdriver. Place the drill with the 7/16" (11 mm) socket on the manual override shaft located at the top of the motor.
3. To retract your jack(s) run the drill in the counter-clockwise direction.
4. To extend your jack(s), run the drill in the clockwise direction.
5. When manual override is complete, return the cartridge valve(s) to the normal positions. Reinstall black plastic cap on motor.

Hydraulic Pump Function Wiring

LOCATION	EXTEND T	RETRACT B
Jack #1 left front	Brown	Brown/Black
Jack #2 right front	White	White/Black
Jack #3 left rear	Orange.....	Orange/Black
jack #4 right rear	Yellow	Yellow/Black

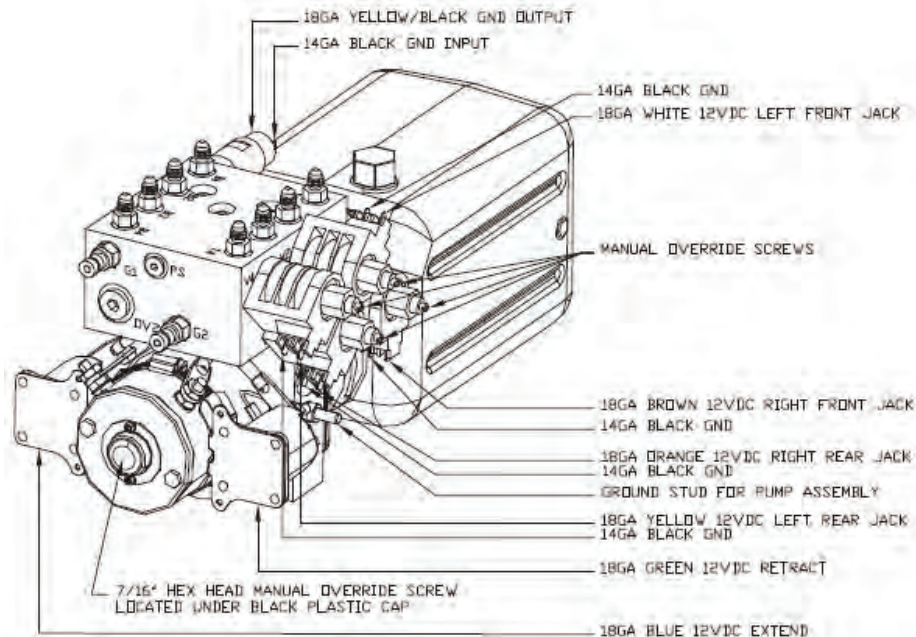

SLIDE OUTS

Refer To The Manufacturer's Operation's Manual For Complete Details And Troubleshooting Guide.

Hydraulic Slide Out

▲ CAUTION Operating the room with any room-locking device locked can cause personal injury and vehicle damage. It is the operator's responsibility to ensure that all room-locking devices are disengaged before operating the room.

Keep people and obstructions clear of room when operating. The Pilot and Co-Pilot seats must be in their most forward position, with seat backs in the vertical setting.

NOTICE The motor home must be level before extending the Slide outs. Make sure there is adequate clearance to fully extend the room.

Do not hold the room control switch in the "extend" position for more than ten seconds after the room is fully extended or stops moving. If either side of the room stops moving, release the room control switch immediately.

Extensive damage could occur to the Slide out room and awning when extending the Slide out room in snow, sleet, ice or freezing rain. In such conditions, if the Slide out room is extended, clear the awning and ensure free movement prior to operating the Slide out room.

Do not leave the Slide out in the extended position during severe weather. Conditions such as high winds or heavy rain may cause damage to an extended Slide out.

Debris trapped under the Slide out room could result in damage to the floor.

Continuous operation of the Slide out could cause a drain on the coach batteries and damage to the Slide out motor.

 **Note:** The ignition switch must be in the off position to operate the Slide out system.

 **Note:** Erratic operation of the Slide out may be caused by low voltage to the hydraulic pump. Be sure to keep house batteries fully charged to prevent erratic operation.

 **Note:** Releasing the ROOM CONTROL SWITCH will halt the operation of the room.

To Extend Slide Out

1. Level the motor home.
2. Ensure there is proper clearance to fully extend the Slide Out.
3. Apply the parking brake and activate the coach battery disconnect switch.
4. Unlock the Slide out locks by pressing and holding the LOCK SWITCH in the "UNLOCK" position, if equipped.

 **Note:** Rooms with travel locks require both locks to be fully retracted (unlocked) before power to the Slide out switch is restored.

5. To extend the Slide out press and hold the ROOM CONTROL SWITCH in the "EXTEND" position. When the slide out is fully extended, release the ROOM CONTROL SWITCH.

To Retract Slide Out

1. Ensure proper clearance by clearing any obstruction in the Slide out area.
2. Apply the parking brake.
3. To retract the Slide out, press and hold the ROOM CONTROL SWITCH in the "RETRACT" position. When the Slide out is fully retracted, release the ROOM CONTROL SWITCH.



Note: When retracting Slide outs, a delay may be present until the hydraulic pump builds enough pressure to pull the room in. Just continue to press the switch until the room retracts.

4. Lock the Slide out locks by pressing and holding the LOCK SWITCH in the "LOCK" position, if equipped.

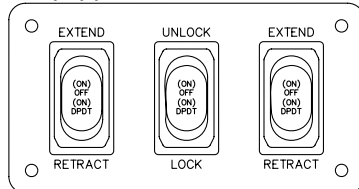

Hose Color Identification

LOCATION	EXTEND (T)	RETRACT (B)
Slide 1 (Driver's Side Front).....	Green.....	Green/Black
Slide 2 (Driver's Side Rear)	Purple	Purple/Black
Slide 3 (Passenger Side Front).....	Gray	Gray/Black
Slide 4 (Passenger Side Front).....	Red	Red/Black

HOSE CONNECTION IDENTIFICATION
T = EXTEND
B = RETRACT

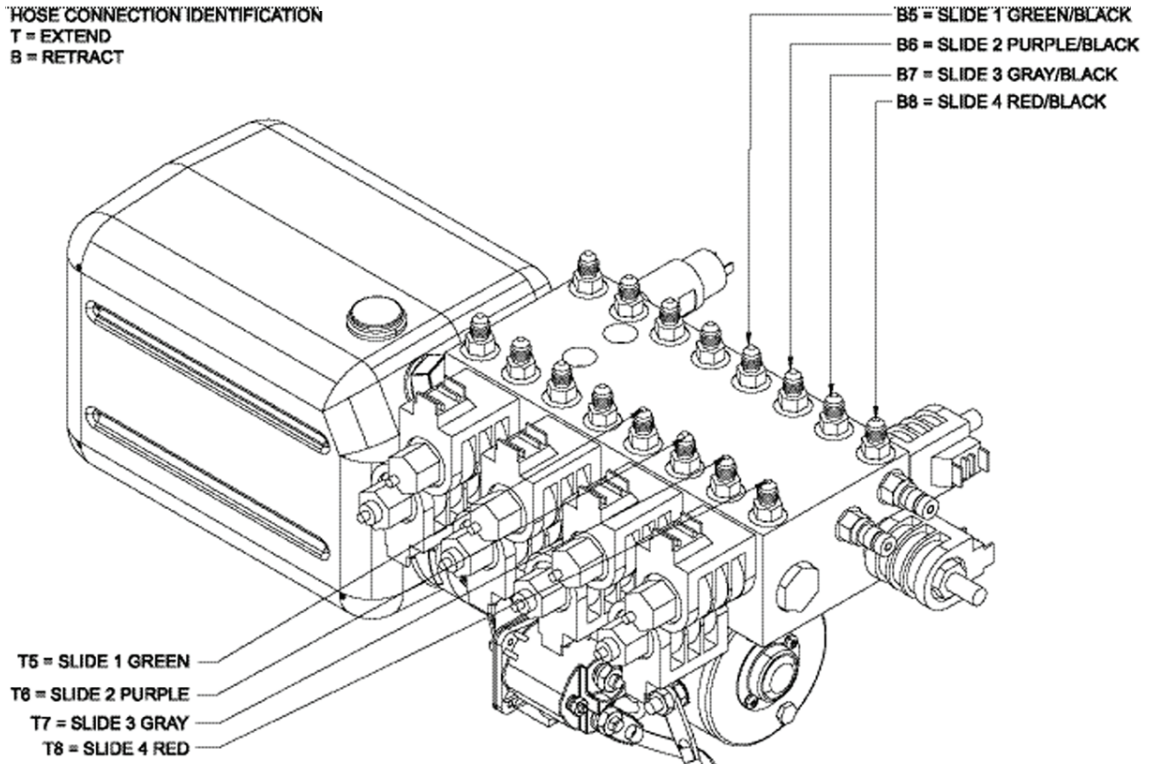

Electric Slide Out

Keep people and obstructions clear of room when operating.

Operating the room with any room locking devices in place can cause personal injury and vehicle damage. It is the operator's responsibility to ensure that all room locking devices (if equipped) are disengaged before operating the room.

CAUTION The motor home must be level before extending the Slide out room(s). Failure to do so may result in structural damage to the motor home.

NOTICE **BEFORE EXTENDING OR RETRACTING SLIDE OUT ROOM:** Be sure that the driver's seat is in the forward position and the seat-back is straight up. Slide out room will contact chair if chair is improperly positioned.

To Extend Slide Out



Note: Make sure that there is adequate clearance to fully extend the room.

1. Apply the parking brake
2. To extend the room, press and hold the ROOM CONTROL SWITCH in the “OUT” position. When the room is fully extended, release the ROOM CONTROL SWITCH.



Note: Releasing the ROOM CONTROL SWITCH will halt the operation of the room.

To Retract Slide Out

1. Make sure to clear any obstruction in the slide-out area, and set the parking brake.
2. To retract the room, press and hold the ROOM CONTROL SWITCH in the “IN” position. When the room is fully retracted, release the ROOM CONTROL SWITCH.
3. Install the room locking devices if equipped.
4. If the room will not retract, refer to the “Manual Retract Procedure”.

Electric Slide Out - Manual Room Retraction Procedure



Note: Please consult Thor Motorized Services for information regarding this procedure.

WINDOWS

⚠ WARNING To avoid exhaust gas entry into the motor home, keep windows closed when the chassis or generator engines are running.

All the windows that open in the motor home are operated by sliding them back and forth. To operate, pivot the latch to release it from the locked position, and slide the window to open. When closing, slide the window fully closed, and pivot the latch back to the fully locked position. The screens will also slide open and closed if required for an emergency exit.

 **Note:** Check window sealant during normal washing and per the Care And Maintenance section of this manual.

DOORS, DRAWERS AND STORAGE COMPARTMENTS

⚠ WARNING Make sure before operating the motor home, that all cabinet doors and drawers are closed, and cabinet contents are secure. Retract and secure sliding doors in the bath area, as well as the bath door, to prevent noise and/or damage while traveling.

Store items in the areas designated for storage. DO NOT store anything in the area reserved for the converter and electrical panels or the water tank and pump.

Cabinet and closet doors in the motor home have door fasteners, or pneumatic stops, which prevent them from accidentally opening during travel. Drawers throughout the motor home have travel stops which keep them from sliding out when in motion (under normal driving conditions).

Bed Storage (Some Models)

⚠ CAUTION Use caution when lowering the bed to keep hands and fingers at the end ledge provided; and not on the side or further back than necessary, where you may encounter pinch points.

SLEEP NUMBER BED

Sleep Number Bed by Select Comfort™ uses unique air chambers designed to provide a gentle cushion of support. Both sides of the bed can be individually adjusted to the precise comfort level each partner prefers by using the Firmness Control System™.

Fluctuations of the Sleep Number® are normal, and may occur with any of the following:

- Changes in body position on the bed (lying down vs. sitting up).
- Changes in the amount of weight on the bed (one person or two people).
- Changes in barometric pressure or temperature.

 **Note:** It is important to be lying on the bed, in your normal sleep position, when checking or making changes to your Sleep Number®.

 **Note:** The coach must be plugged into the Shore Power or Inverter Power supplied if equipped, for the sleep number bed to function.

Using the Firmness Control System™:

- The Firmness Control System™ is designed to make changes to one side at a time. When the Sleep Number® disappears from the wired remote display, changes may be made to the other side.
- To adjust the mattress to a firmer setting, push the UP arrow on the wired remote.
- To adjust the mattress to a softer setting, push the DOWN arrow on the wired remote.
- Some Firmness Control System™ pump models may cycle ON and OFF several times as they find the Sleep Number®. Depending on which digital remote you have, a flashing or blank display means adjustments are still in process.
- The Firmness Control System™ may be heard while making changes to the Sleep Number®.

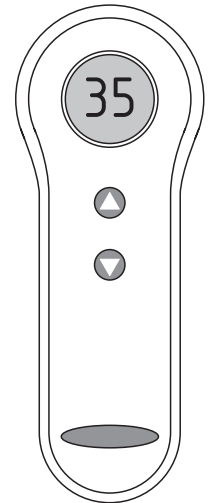

Note: For detailed information regarding the operation and maintenance of the Select Comfort Mattress, refer to the manufacturer's operations guide.

ELEVATED BEDS AND ELECTRIC BED LIFT SYSTEMS

⚠ CAUTION

Each vehicle with elevated beds has a warning label listing the maximum load capacity. Failure to comply with the load capacity could cause bed failure which may result in injury. Elevated beds may present a fall hazard which may result in injury. Please consult the Owner's Manual for more information regarding elevated beds and the use of bed rails.

Standard Elevated Beds – Various Four Winds products are equipped with standard built-in elevated beds or bed loft areas. These beds can be upwards of 4 to 5 feet above the floor level and are often enclosed on one, two, or three sides and sometimes even partially on a fourth side. Because there are so many potential users and different types of elevated bed designs, elevated beds are not equipped with bed rails.

Use of Bed Rails – We feel that you, as the customer, are best equipped to determine if a bed rail system is necessary or best for you based on your intended uses, the actual users of the elevated beds, and the comfort level of the users.

For those customers who would prefer using an elevated bed with a bed rail, there are numerous bed rail styles, sizes, heights, and designs available, even in the style of bumpers, which can be purchased at various retail locations and/or on the internet.

When installing a bed rail please make sure that you follow the manufacturer's installation instructions carefully and that you take in to account the size and height of the mattress (either originally installed by Four Winds or later replaced by you) so that the rails are the appropriate height above the top of the mattress. This is important because residential mattresses differ in size from the RV mattresses originally installed by Four Winds. Please also make sure that the bed rail you select allows for adequate room to get in and out of the elevated bed after installation, especially in the event of an emergency.

Tips for Safe Usage:

- Please use sound judgment when allowing children to sleep in any style of elevated bed. Generally, it is not suitable for children under the age of 6 to sleep in an elevated bed or bed loft area.
- No more than one person should be in an elevated bunk bed at once and make sure you follow the weight restrictions posted on the warning label near the bunk beds. No more than two people should be in a front cab over bed (only available on Class C motor homes).

Tips for Safe Usage:

- Discuss proper usage of any elevated bed/electric bed lift system with your children and make sure they are supervised if playing in the bedroom/sleeping area of the motor home with elevated beds. Please do not allow horseplay on or under the elevated beds and no items such as hooks, belts, jump ropes, or towels should hang from any part of the elevated bed.
- Place a night light in the bedroom/sleeping area so users can see at night when getting in and out of the beds.
- Do not allow children to operate the rear cargo area electric bed lift systems in Toy Haulers. The lowering and raising of the electric beds should be only conducted by an adult. No person should be on the electric beds when being lowered or raised.

If you have any questions about elevated beds, Toy Hauler electric bed lift systems, or bed rails please contact Thor Motorized Services Customer Service Department.

FURNITURE

▲ WARNING Do not occupy beds or any other seats that are not equipped with safety seat belts while the motor home is in motion. Do not use a seat belt on more than one person.

The sleeping accommodations in this motor home are designed for occupancy only while the motor home is parked. All occupants in this motor home must be seated at a designated seating position and must wear seat belts at all times while this motor home is in motion. Failure to do so may result in serious injury.

Safety belts and seats can become hot in a vehicle that has been closed up in sunny weather; they could burn a small child. Check seat covers and buckles before you place a child anywhere near them.

Jack Knife Sofa

SOFA TO SLEEPER

- Unlatch and remove sofa arms (if equipped).
- Raise the sofa seat base until the seat base and backrest form a “V” shape by lifting up from the center of the sofa just below the seat cushions.
- Pull out and push down on the seat base until the seat base is flat.
- Fold the seat belts out of the way.

SLEEPER TO SOFA

- Lift the seat base up until the seat and back rest from a “V” shape.
- Push back and down on the seat base.
- Position the seat belts for use.
- Replace the back rest cushions.

Space Saver Sofa

SOFA TO SLEEPER

- Unlatch and remove sofa arms (if equipped).
- Raise the sofa seat base until the seat base and backrest form a “V” shape by lifting up from the center of the sofa just below the seat cushions.
- Pull out and push down on the seat base until the seat base is flat.
- Fold the seat belts out of the way.

SLEEPER TO SOFA

- Lift the seat base up until the seat and back rest form a “V” shape.
- Push back and down on the seat base.
- Position the seat belts for use.
- Replace the back rest cushions.

Hide -A- Bed Sofa

SOFA TO SLEEPER

- Grasp the front metal bar and lift up, pulling out on the bar slightly until the leg of the bed is resting on the floor.
- Fold the seat belts out of the way.
- When the legs of the bed are on the floor another lifting bar will be exposed, grasping and pulling the lift bar will open the bed fully.

SLEEPER TO SOFA

- Remove all bedding from the hide-a-bed.
- Grasping the foot of the hide-a-bed in the center using the metal lifting bar, lift the front portion of the lifting bar to raise and then lower the hide-a-bed back into the sofa base.
- Position the seat belts for use.
- Replace the seat cushions.

Air Hide A Bed Sofa (Drawer Storage Below)

- Pull back rest section of sofa out and over seat cushions.
- Fold legs up.
- Rotate till legs rest on floor.
- Unfold air mattress, plug in, fill with air.



Note: Do not fold the air mattress up in the sofa. Damage will occur.

Air Hide A Bed (No Drawer Storage Below)

- Remove back rest cushions.
- Pull seat cushion section up and out
- Rotate bottom of seat cushion out and fold legs down.
- Fold back rest down to create platform.
- Unfold air mattress, plug in, fill with air.



Note: Do not fold the air mattress up in the sofa. Damage will occur.

Barrel Chair

The barrel chair has controls on the bottom right and left sides under the chair skirt that controls the swivel and side to side action of the chair.

Euro Recline With Ottoman

To recline, sit down, grasp the armrest's and lean back to recline. Since a seat belt is not provided, do not use the euro recliner while in transit.

Dinette

Booth

The dinette will seat four people. Storage and/or various systems components can be accessed from above by removing the seat cushions and lifting the seat supports.

Free Standing

Since the free standing dinette chairs are not secured to the floor, and not equipped with seat belts, they should not be occupied while the motor home is in motion. These chairs should be stored securely while the vehicle is in motion.

Pedestal

The dinette can also be converted into an additional bed if required. To convert, lift the table top off of the two support posts. Remove the support posts from the floor and lay them down between the seats. Insert the table top between the seats on the ledges provided. Loosen the seat cushion from the Velcro fasteners and slide each together to form the bed. Reverse this process when reconverting to the dinette configuration.

Wall Mounted

This dinette can also be converted into an additional bed. Lift the aisle side of the table and pinch in the pins on the table leg to collapse the leg. Unhook from side wall and swing into place. The table supports on the dinette base. Loosen the seat cushion from the Velcro fasteners and slide each together to form the bed. Reverse this process when reconverting to the dinette configuration.

Lounge Table

This table is stored in a folded position next to the barrel chair. To raise for use, pull out on the bottom to release it from its securing catch, and swing up. When raised, reach under the table and swing the supporting leg down until it locks into position. Adjust the length of the support leg, so that the table will be level when resting on it. To adjust the support leg length, pull back on the spring clip, releasing the detent from the adjustment hole it is presently in. While holding the spring clip back, slide the leg to the desired length, then release the spring, allowing the detent to lock into the new hole.

To fold back for storage, reverse the previous procedure; shortening the support leg, and folding the leg up against the bottom of the table top. Lower the table top, and push in on the bottom to secure it into the catch that keeps the table from moving while traveling.

Pilot And Co-Pilot Seats

▲ WARNING Pilot and Co-Pilot seats must be locked in a forward facing position with seat belts fastened while the motor home is in motion. Avoid seat rotation while in transit.

Reclining Back

A control lever on the left or right side of seat controls the angle of the back rest. Lift up on the lever, lean back to position seat and then release the lever to lock the back rest in place. To return the backrest to upright position, lift up on the control lever. It will automatically return to its normal upright position. **To prevent damage, be sure to return the seat back to it's upright position before operating the slide out rooms.**

Seat Swivel

A control lever on the side of seat controls the swivel function. Push the lever forward to release the detent on the swing mechanism. Once the lock is released, the seat may be rotated either left or right.

Forward And Back Adjustment

The forward and back sliding action is controlled by a lever on the lower left side of the seat. To adjust, pull the lever outward to release the latch, and slide the seat to the desired position. Make sure the seat locks into the position you have selected.

Arm Rests

Arm rests can be rotated up and out of the way when not required.

 **Note:** It may be necessary to adjust the sliding position of the seat and the tilt of the back, to enable the seat to be rotated without obstruction from sidewalls or items to the rear. Some models do not allow complete seat rotation.

ENTRY DOOR

The entry door consists of both an exterior door and a screen door used for ventilation when the motor home is parked.

⚠ CAUTION **DO NOT attempt to drive the motor home with the doors open. DO NOT drive the motor home with the outer door open and the screen door closed. The doors may be damaged, and it is a safety hazard.**

When driving, it is a good idea to keep the door locked to prevent uninvited entrance from the outside when stopped. Two types of locks may be provided with the outer door. The handle lock for normal security, and a dead bolt lock for additional security. The dead bolt must be locked while driving.

The screen door can be attached to the outer door. A sliding panel on the screen door permits access to the handle on the outer door to prevent unnecessary handling of both doors. Separate keys are provided for both types of door locks. It is a good idea to keep a record of the key numbers in a safe place, should it become necessary to have duplicate keys made.

ENTRY STEP

⚠ WARNING **Make sure before exiting the motor home, that the step is activated and/or extended. Due to the height of the motor home, you may accidentally slip or fall if attempting to exit without use of the step. If the step will not operate, use extra care when exiting. Never activate the step when someone is using it, and be sure to keep hands, feet, children, and pets away from the mechanism when activated.**

NOTICE **If the motor home is driven with the step in the extended position, there is the possibility of causing major damage to both the step and the motor home.**

The entry step features amber lighting under the step, and automatic retraction with the ignition key in the ON position. The power switch for the entry step is located on the passenger armrest.

STEP OPERATION:

1. With the entrance door open, turn the override switch to the OFF position. Close the door. The step should retract and lock in the 'up' position.
2. Open the door. The step should extend and lock in the 'down' position with the under step light illuminated.



THE UNDER STEP LIGHT OPERATION:

1. The light is ON when the step is extended.
2. The light is OFF when the step is retracted.
3. Turn the override switch to the ON position. The step should remain in the extended position with the under step light OFF when the door is closed.
4. With the override switch turned ON, the step extended, and the entrance door closed, turn the vehicle ignition ON. The ignition override system will go into effect and the step will automatically retract.
5. Turn the vehicle ignition OFF and open the door. The step will extend and lock in the 'down' position. This is the 'Auto Extend' feature. When the vehicle ignition is turned ON, the step will always activate with the door movement, regardless of the override switch position.

 **Note:** If the override switch is OFF and the step is extended and the door is left open, the light will turn OFF after five minutes. The under step light is not available on all step models.



Note: If the yellow wire from the four-way connector is not connected to an ignition power source, the ignition safety system will be inoperative and the step will remain in the extended position. In this case, the override switch must be turned OFF for the step to retract.

STORAGE COMPARTMENTS



CAUTION When closing the storage doors make sure that hands and fingers are clear of pinch points. Make sure all compartment doors are completely closed, latched and contents are secure prior to moving the motor home.

The motor home is equipped with numerous outside storage compartments. Each door can be locked for security, except for the Propane Gas compartment.



Note: Ensure proper clearance is available for the door to open.

When storing items within the compartment bays, do not overload them with heavy densely packed items, remember that any weight added to the motor home affects the overall weight of the vehicle. Ensure that side-to-side weight is comparable to distribute the load evenly.

REAR LADDER/ROOF ACCESS



WARNING Do not climb on or walk on the roof while wet. The roof could be very slippery causing you to fall, which can result in serious injury or death. Do not use the roof as an observation platform or storage area, as it is not designed for these purposes.

The exterior rear ladder provides access to the roof for maintenance of the roof and roof mounted items only. When ascending and descending the ladder, ensure the ladder is clear of debris, such as water, ice and other slippery substances. Always wear shoes that provide good traction, and do not wear sandals or other types of slip-on footwear when ascending or descending the ladder.



Note: The rear ladder maximum weight capacity is 250 lbs.

AWNINGS



CAUTION If threatening weather approaches, you need to retract all awnings. If the awnings are rolled up wet, open them back up as soon as possible to allow them to dry. Also, do not drive during periods of high winds.

Slide Out Awning

The Slide out Topper will automatically open and close as the slide out room opens and closes. Because the awning is level, water may puddle on top of the canopy. As the slide out room is closed and the awning rolls up, these puddles may spill over the sides of the awning.



Note: For detailed information regarding the Slide out Topper Awning refer to the A & E Systems, Slide Topper Installation And Operating Instructions Manual.

Manual Patio Awning

Extend the Awning

- Release both travel clamps (one on each arm, about midway up)
- Using the provided awning rod, rotate the Safe-T-Lock lever up to the UNLOCK/OPEN position.
- Hook the awning rod into the pull strap loop securely and pull the awning out. Once extended, slide the pull strap to the right and wrap the strap around the awning arm.

 **Note:** Prior to closing, remove tie downs and screen if used. Ensure that the travel strap and buckle are clear of the back channel.

Retract the Awning

- Unwrap the pull strap from the awning arm and slide it slightly to the left.
- With one hand, firmly grip the awning pull strap and gently pull down, while at the same time, using the awning rod to rotate the Safe-T-Lock to the UNLOCK/CLOSE position.
- While holding the pull strap firmly, hook the awning rod into the pull strap loop and slowly allow the awning to retract, controlling the speed with the awning rod in hand.
- Once the awning has fully retracted, reconnect the travel clamps.

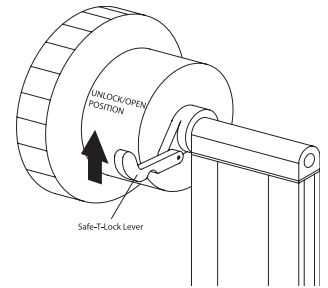

Automatic Patio Awning

⚠ CAUTION In the event of power loss or awning motor failure the Automatic Patio Awning can be retracted as explained below. If you do not feel comfortable performing this procedure, contact the nearest authorized service center for assistance. Do not drive the motor home with the awning in the extended position.

Extend the Awning

- Press and hold the remote switch (located near the entrance door) in the extend position until the awning is fully open or utilize the remote control, if equipped.

 **Note:** Do not press more than one “EXTEND” button at the same time. Awning will not work and/or may cause control box fuse to blow.

 **Note:** Not all awnings have a control box.

Retract the Awning

- Press and hold the remote switch in the retract position. When awning is fully closed release the switch.

 **Note:** Do not press more than one “RETRACT” button at the same time. Awning will not work and/or may cause control box fuse to blow.

Manually Closing The Automatic Awning:

Please consult your owner's manual for complete instructions or a qualified service technician.

 **Note:** The awning must be serviced by a qualified service technician before attempting to open the awning after this procedure has been performed.

GARAGE AREA (AVAILABLE ON SELECT MODELS)



DANGER

Any motorized vehicle or any motorized equipment powered with flammable liquid can cause **FIRE AND EXPLOSION OR ASPHYXIATION** if stored or transported within the motor home.

To Reduce The Risk Of Fire, Explosion Or Asphyxiation:

1. Do not allow passengers to ride inside the internal combustion engine vehicle storage area while vehicles are present.
2. Do not allow occupants to sleep in the vehicle storage area while vehicles are present.
3. Doors and windows in walls of separation (if installed) must be closed while vehicles are present.
4. Run fuel out of engine after shutting off fuel at the tank.
5. Do not store or transport supplementary motor fuel within this vehicle.
6. Ventilate the interior of the vehicle to reduce the risk of fire, explosion or asphyxiation.
7. Do not operate gas appliances, pilot lights, or electrical equipment when motorized vehicles or motorized equipment are inside the vehicle.
8. Do not operate motorized vehicles while the rear door is closed.

Failure to comply could result in an increased risk of fire, explosion, asphyxiation, death or serious injury.

Loading an internal combustion engine or other materials inside of cargo storage area will affect the weight distribution of the motor home. Adding weight to the unit behind the rear axle will reduce weight to the front axle. This may adversely affect handling of motor home while in transit. Adding the weight behind the rear axle also adds to the weight load on the rear axle. Do not over load the rear axle weight rating.

Cohabiting with an internal combustion engine vehicle can be hazardous to your health. Fumes from fuel can cause fire, explosion, or asphyxiation.

Fold-Down Ramp



CAUTION

Keep all personnel clear of ramp working area while raising or lowering. Keep all objects clear of pinch points when raising and lowering platform.

Keep the loading area clean and free of clutter and debris. Keep the ramp and floor dry by cleaning up all spilled water, oil and fuel as soon as possible.

The fold-down ramp gives complete access to the cargo area. When lowered, the ramp allows easy loading of rolling cargo, bicycles, motorcycles, ATV's and other small vehicles.

When loading and unloading always walk items up and down the ramp. Never ride a vehicle or bicycle on the ramp.

Always wear shoes that provide good traction, and do not wear sandals or other types of slip-on footwear when ascending or descending the ramp.



Note: Refer to the fold-down ramp manufacturer's operations manual for detailed information regarding the proper usage of the fold-down ramp.

HEATING AND AIR CONDITIONING

DASH PANEL HEATER AND AIR CONDITIONER

The air conditioning system contains refrigerant 134a under high pressure and should be serviced by qualified personnel only. Improper service methods could cause serious personal injury.

The motor home is equipped with an integrated heating/air conditioning system. While this system is much more powerful than those used in passenger cars, it is not capable of heating and cooling the entire motor home. This system is designed to provide windshield defrost as well as heating and cooling for the front seat occupants only. By following the operating instructions and tips, this heater/air conditioner will provide many years of comfort and dependable service.

The heater/air conditioner unit is located beneath the dash on the passenger side of the vehicle with heating and cooling coils located on the outside of the fire wall. In most modes of operation the unit takes fresh air from outside, and heats or cools it before discharging into the motor home. Only when operated in the MAX A/C mode does the system take air from inside the motor home.

Control Panel

The control panel enables the driver to control the temperature, volume and direction of the air discharged from the heating/air conditioning system.

One of the best ways of controlling temperature is by changing the speed of the blower. The blower knob (left of center) provides 4 speeds in any mode except OFF. The center knob controls the temperature of the discharge air. Turn the knob to the right (red area) for warmer air, and to the left (blue area) for cooler air.

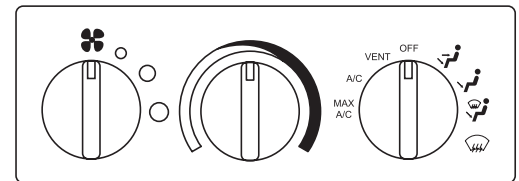

A/C CONTROL PANEL

Operating Features

The air conditioning system is designed to operate in all modes except VENT, FLOOR and OFF. This provides significant moisture, dust and pollen removal for enhanced passenger comfort. Use MAX A/C and HI blower for quick cool down. A lower blower speed produces cooler air. To assist with cooling, close all windows and vents to hot, humid outside air.

 **Note:** The A/C will not function if the outside air temperature is below approximately 40° Fahrenheit.

 **Note:** In the event control vacuum is lost, the system is designed to discharge through the defrost vents.

To achieve the maximum comfort in the motor home, the air must be directed where it is needed. The mode switch (right of center) gives the driver the ability to select where the air will flow.

Keep the condenser and radiator free of bugs and debris. During periods of little use, operate the A/C system monthly to keep the compressor lubricated. Periodically inspect belts and hoses for wear and proper tension.

Warranty/Service

If repairs are necessary during the terms of the motor home warranty, please contact the nearest authorized Four Winds International dealer for service. In the event repairs are necessary during transit, contact Four Winds Customer Service. Certain individual parts of the Heating and Air Conditioning System such as the compressor, dryer and condenser are covered under the chassis manufacturer warranty.

 **Note:** Components covered under the Four Winds International Limited Warranty must be Original Equipment Manufacturer (OEM) parts. The installation of after market components, or unauthorized repairs may void the warranty.

ROOF MOUNTED AIR CONDITIONER

The motor home is equipped with a roof mounted air conditioner. This air conditioner operates from 120 Volt AC only, either from shore power or the on-board generator. Air conditioner functions are controlled by the comfort control panel.

Performance Characteristics

You can expect to see up to 15 to 20 degree differences in temperature between the closest A/C outlet vent and the return air inlet grill under most operating conditions.

Factors that can affect the performance of the cooling system:

- Use window and patio awnings when outside ambient temperature is above 95° F to help deflect the Sun load during the heat of the day. If window awnings are not installed then use shades or blinds to deflect the Sun.
- Try to avoid using the cook top or oven when the ambient temperature is over 95° F.
- Keep windshield covered when facing the afternoon Sun when parked.
- The number of windows within the slide outs and the number of cold air registers to handle heat gain when facing the afternoon Sun.

Return Air Filters

NOTICE DO NOT USE HARSH CHEMICALS OR SOLVENTS TO CLEAN THE FILTER.

Clean the return air filters as needed for the environment in which they operate. The return air filters are inside the air intake vent covers located on the motor home ceiling. Never operate the air conditioners without the return air filters in place. Doing so may result in the build-up of dirt on the evaporator core affecting the performance of the air conditioner.

TO CLEAN: Remove the vent cover and filter and wash in warm soapy water. Rinse the filter and cover thoroughly with fresh water and Allow to dry. Reinstall the filter and cover.

FURNACE

⚠ CAUTION This appliance is equipped with an electric ignition device which automatically lights the burner. Do not try to light the burner by hand.

Furnace Operation Instructions

1. The propane tank must be filled and the house batteries should be fully charged.
2. The propane valve located on the propane tank must be in the open position. The valve should only be opened or closed by hand. If the valve cannot be turned by hand, have the valve checked by a qualified service technician.
3. All power to the appliance should be on. Breaker and 12 Volt fuse locations vary depending on floor plan.
4. Set the thermostat to the desired function and temperature setting.

 **Note:** For detailed information regarding the Furnace refer to the manufacturer's operating instructions manual.

THERMOSTATS

 **Note:** For detailed information regarding the thermostat refer to the manufacturer's operating instructions manual.

Certain roof mounted air conditioners have self contained thermostats and controls which are located at the return air grill.

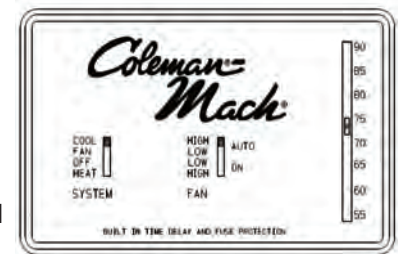

A Cool, Fan and Heat thermostat, with a manual, "Cool", "Fan" and "Off" and "HEAT" comfort switch. The thermostat can be operated in both manual (ON) and automatic mode (AUTO), on either high or low. Set your temperature with an easy slide temperature selector.

CEILING VENTS

Vents are provided in the motor home to circulate fresh air and exhaust odors.

Exhaust Vent

The power vent includes a 12 VDC powered fan. A hand crank controls opening and closing and adjustment of the vent cover, while a push button turns the exhaust fan ON and OFF. Make sure to turn the fan OFF before closing the vent. Also be sure to remove any debris that falls into the vent that may restrict operation.

 **Note:** For best results, close all other roof vents and open one window, or door the greatest distance from the exhaust vent.

 **Note:** The dome must be open prior to operating the fan motor.

 **Note:** Refer to the operation manual for proper long term storage procedures.

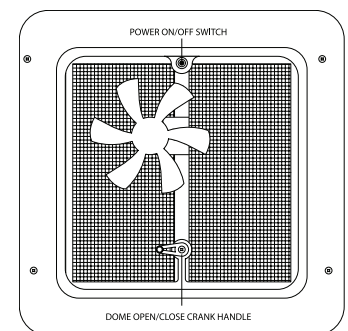



Attic Fan - Fantastic Vent

The fan is a three-speed fan which can extract air from the motor home. To operate the fan use the following guidelines:

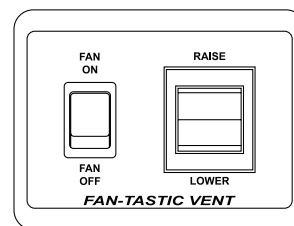
- Turn the fan speed control dial to the desired performance level (0 - Off, 1 - Low, 2 - Medium, 3 - High). By selecting the "0" setting, the fan acts as a vent only.
- Slightly open a window for maximum air flow.
- Set your interior temperature on the wall mounted thermostat between 60° F and 90° F. When the interior temperature is warmer than setting, the dome opens automatically and the fan blade turns on to the pre-selected speed.
- If your vent is supplied with a rain sensor, no other action is necessary on your part in the event that the rain sensor has moisture on it.
- **Manual Dome Operation:** Use the dome hand crank knob only in an emergency or for dome adjustment. Pull the knob to the desired dome placement. Push the knob back upward. Ensure that the knob is locked in place.



 **Note:** A vent cover is not recommended or foam filter is not recommended on Fantastic Vent.

 **Note:** Refer to the owner's manual for complete instructions and proper long term storage procedures.

Attic Fan - Create A Breeze

The fan has three speeds.

- Open dome approximately 3 inches or more by turning the hand crank. The fan has a built in safety switch that will not allow motor to operate unless dome is partially open.
- Turn 3 speed knob to desired performance level (0 - Off, 1 - Low, 2 - Medium, 3 - High)
- Slightly open window of your choosing for maximum air flow.

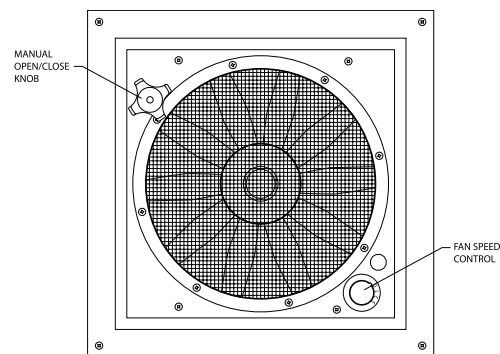

Recommendations: You may use your Create A Breeze while driving or in windy conditions. In this case keep your dome fully open.

 **Note:** A vent cover or foam filter is not recommended on vent.

 **Note:** Refer to the owner's manual for complete instructions and proper long term storage procedures.

ELECTRICAL SYSTEMS

NOTICE

The electrical system is engineered and tested for safety. Circuit breakers and fuses protect the electrical circuits from overloading. If you plan to make modifications or additions to the electrical system, Four Winds International strongly recommends consulting a certified electrician for assistance to ensure continued integrity and safety of the electrical systems. Please note that any modifications may void the Limited Warranty.

The electrical power supply provided for the motor home is a dual system, operating with 120/240 volt AC and or 12 Volt DC. The 120 Volt power may be provided by either connecting the motor home to an outside power source when parked, or by use of a motor home generator. When the 120 Volt system is operational, power also passes through a system converter, allowing the full use of all 12 Volt functions in the motor home.

120 Volt appliances in the motor home include the refrigerator, ice maker, roof mounted air conditioner(s), TVs, DVD player, microwave oven, converter and the water heater. The refrigerator also has the option of running on propane gas when 120 Volt power is not available. All other electrical functions in the motor home are supplied with 12 Volt power.

When it is not possible to access 120 volt power, the 12 Volt system functions can be supplied by the auxiliary batteries. The chassis battery is protected by a battery isolator controller to prevent discharge from excessive electrical consumption when the motor home is not running. The auxiliary batteries are recharged by the power converter when the motor home is attached to an outside 120 volt power source, or by the generator when it is running, and by the chassis alternator when the chassis engine is running.

SHORE CORD

⚠ DANGER

CONNECTING THE SHORE CORD TO A NON-GROUNDED OR IMPROPERLY GROUNDED POWER SOURCE CAN RESULT IN DANGEROUS AND POSSIBLY FATAL ELECTRIC SHOCK. DUE TO THE POTENTIAL DANGER IN FAILING TO HEED THIS WARNING, THE MOTOR HOME MANUFACTURER CANNOT BE RESPONSIBLE SHOULD DAMAGE, INJURY, OR DEATH RESULT FROM FAILURE TO CONNECT THE POWER CORD TO A PROPERLY GROUNDED POWER SOURCE.

⚠ WARNING

If shore power service is limited to 15 or 20 amps, use of light duty extension cords and electrical adapters will create a Voltage loss through the cord and at each electrical connection. Line Voltage loss and the resistance at each electrical connection can be a hazardous combination. Damage to sensitive electronic equipment may result.

30 Amp Shore Power

⚠ WARNING

The motor home is designed to be connected to a 30 amp service which provides 120 Volts. The motor home should never be connected to any power source that will provide anything more than 120 Volts. Failure to follow this will result in serious damage to internal items that are plugged in.

A 30 amp shoreline power cord is provided to attach the motor home to a grounded power source. When connecting or disconnecting from a grounded external power source, always turn off the shore power breaker to the power supply outlet. This will prevent accidental shock and flashing of electrical contacts.

50 Amp Shore Power

⚠ WARNING The motor home is designed to be connected to a 50 amp service which provides a combined total of 240 Volts. The 240 Volts comes from two separate 120 Volt lines that are in the shore power cord. The motor home should never be connected to any power source that will provide anything more than 120 Volts on either line coming in. Failure to follow this will result in serious damage to internal items that are plugged in.

A 50 amp shoreline power cord is provided to attach the motor home to a grounded power source. When connecting or disconnecting from a grounded external power source, always turn off the shore power breaker to the power supply outlet. This will prevent accidental shock and flashing of electrical contacts.

 **Note:** These three shore power outlets are most commonly used throughout the United States:



50 Amp



30 Amp



15-20 Amp

BATTERIES

The chassis and or auxiliary batteries of a motor home may be located behind the front hood of the motor home or in an exterior compartment.

It is important to make sure that batteries are kept charged. Take time to turn off all lights or other 12 Volt conveniences when not in use. Connect the motor home to a 120 volt power supply when possible, instead of draining the batteries. The charge condition of the batteries can be checked with the monitor panel. To check, press and hold monitor test switch while reading the charge level on the battery gauge. Charge levels indicated are divided into sections from weak through fully charged.

Battery Safety

⚠ DANGER BATTERIES CAN EXPLODE! Always wear splash proof safety glasses when working near batteries. Do not smoke or expose any battery to electric sparks or flame. Batteries, when charging or discharging, generate hydrogen. Hydrogen and air is a very explosive mixture.

⚠ WARNING Do not short across the battery terminals. The spark could ignite the gases. Do not wear metal jewelry or a watch when working on a battery.

Before doing ANY work on electrical system, disconnect battery cable and the 120 volt power cord. Do not reconnect the cables until all work has been completed. This will avoid the possibility of shorting or causing damage to electrical components or shock to the servicing person.

Battery electrolyte is a corrosive, poisonous, sulfuric acid. Avoid contact with skin, eyes, clothing, or any painted surface.

Sulfuric acid in the batteries can cause severe injury or death. Sulfuric acid can cause permanent damage to eyes, burn skin and eat holes in clothing. Always wear splash-proof safety goggles and gloves when working around the battery. If battery electrolyte solution is splashed in the eyes, or on the skin, immediately flush with clean water for 15 minutes. In case of eye contact, seek immediate medical treatment. Never add acid to a battery once the battery has been placed in service. Doing so may result in hazardous splattering of electrolyte solution.

Battery Maintenance

Battery maintenance is important. Checking the condition of a battery at regular intervals will help insure its proper operation. Here are some recommendations for checking and servicing batteries:

 **Note:** These instructions only apply to batteries other than maintenance-free batteries. Do not open or break seals on maintenance-free batteries.

1. Keep the battery mounted securely. Vibration causes early failure of many batteries.
2. Check the electrolyte level of the auxiliary batteries at regular intervals. Keep each cell filled to just above the plates with distilled water. Once the plates have dried out, they cannot be reactivated, and the capacity of the battery is reduced in direct proportion to the area of plate surface that has become dry. This kind of damage can occur quickly; usually it can happen overnight. If the fluid level is low, simply add distilled water.
3. Keep the battery clean. Corroded terminals make poor contact and do not allow the chassis alternator or the converter to bring the battery up to full charge. Battery sulfation occurs when the battery has been standing in a discharged condition over a long period of time, or when the battery has been operated continually in a state of partial discharge. Use a baking soda solution to neutralize the acid accumulations on the battery top. Do not allow the soda solution to enter the battery. Make sure the vent caps are secure. Flush with water. Thoroughly dry all cables and terminals, reinstall, and use a plastic ignition spray to protect the terminals.
4. Check the outside condition of the battery. Look for cracks in the case or vent plugs. If the case is cracked, the battery must be replaced. If the vent plugs are cracked, they must be replaced.
5. Watch for overcharging. Three indications of overcharging are:
 - a. Active material on the vent cap (heavy deposit of black lead-like material on the underside of the vent cap) .
 - b. Excessive use of water.
 - c. Voltage regulator output.
6. Make sure the battery hold downs and carrier are kept clean and free of corrosion.

When removing a battery, disconnect the ground battery clamp first. When installing a battery, always connect the grounded battery clamp last.

When a battery needs to be replaced, make sure to replace it with a battery of the same characteristics as the original equipment. Consult your dealer for advice on battery replacement.

Battery Isolator Controller

When the motor home engine is not running, the chassis and auxiliary batteries are kept separated from each other within the electrical system through the use of a battery isolating controller. The controller prevents the auxiliary batteries from discharging the chassis battery when the motor home is parked.

Some additional characteristics of the isolator system include:

1. Delays connecting the auxiliary batteries to the charging system for approximately 15 seconds, to allow the alternator time to reach full charging ability.
2. After this initial time delay, if the alternator has come up to full charging ability, (13.2 Volts) the isolator will electrically connect the auxiliary and chassis batteries together for charging.
3. If the charging voltage drops below 13.2 Volts for a period of 4 seconds due to low idle speed and or excessive load, the isolator will disconnect the auxiliary batteries until the voltage returns to a level of 13.2 volts for about 10 seconds.
4. In the event the automotive battery is discharged, it will be necessary to press and hold the Start Switch located in the dash.

 **Note:** When operating 12 Volt equipment from battery, reduce equipment in use to conserve battery. Gradual dimming of lights, and slowing of motors indicates low battery voltage.

Battery Disconnect Switch

The battery disconnect switch allows you to easily disconnect the auxiliary batteries from electrical circuits, preventing unwanted discharge during extended non-use. The switch(s) is/are mounted on a panel near the entrance door.

There are two main uses of the battery disconnect:

1. Prevent unwanted discharging of batteries during extended periods of storage.
2. Prevent shorts or fire hazard while working on the 12 Volt electrical system.

When activating, place the switch for the desired battery system in the ON position. This battery system will now be operational. The disconnect switch must be in the ON position while plugged into shoreline power to charge the battery(s). Place the switch in the OFF position to disconnect 12 Volt circuits.

 **Note:** If 12 Volt functions are not working, be sure to check that the battery disconnect switch has been placed in the ON position.

Battery Charging

⚠ WARNING ALWAYS WEAR SPLASH PROOF SAFETY GLASSES WHEN WORKING WITH BATTERIES.

The converter/inverter also operates as a battery charger when it is connected to a 120V power source. If the battery is below its full charge, the converter/inverter charger will begin operation at a rate that reflects the level of discharge. When the battery is again fully charged, the converter charger drops its charging level back to a maintenance level to keep the battery fully charged.

If for any reason you charge a battery with a source outside the motor home, make sure to follow the rules of battery maintenance and safety outlined in this section. Also observe these additional safety precautions related to battery charging:

1. Disconnect the battery from the motor home.
2. Check electrolyte before charging. Be sure each cell is properly filled with distilled water.
3. Make sure to use care when connecting and disconnecting the cables from chargers. A poor connection can cause an electrical arc, which can result in an explosion.
4. Remove the battery vent caps before charging, and make sure that the electrolyte does not splash out as a result of charging too quickly.
5. Check literature supplied by battery manufacturer, and follow warnings or cautions outlined.

POWER CONVERTER

The converter is used to switch 120V electricity from an external supply, or from the generator, to 12 Volt electricity to power interior lights and 12 Volt accessories. The converter requires no maintenance under normal circumstances.

If the converter does not have a 120V supply to convert to 12 Volt, it automatically switches the batteries into the electrical circuit to power 12 Volt functions. When reconnected to a 120V supply, it will again operate from this power source.

The converter will run warm and this is normal. If, however, it gets too hot, it will turn itself off. After it cools down, it will come back on. In most cases, when this happens it is because something has been put around or too near the converter preventing it from receiving adequate ventilation. Make sure not to put anything near the converter that could obstruct ventilation.

A slight hum during operation is also normal for the converter, if you do not have 12 Volt power and no hum, check to see if 120 volt power to the converter has been interrupted.

POWER INVERTER - DIESEL **DIESEL ONLY**

The inverter takes 12 Volt DC from the house batteries and turns it into 120 Volt AC. It also takes 120 Volt AC when the motor home is connected to shore power and transforms it into 12 Volt DC to recharge the house batteries.

There are two modes of operation associated with an inverter/charger:

1. **Inverter Mode:** 12 Volt DC from the coach batteries is transformed into 120 Volt AC for use with household electrical appliances.
2. **Charger Mode:** 120 Volt AC is taken directly from shore power (or other AC sources) and passed directly to household appliances. At the same time, the incoming 120 Volt AC is also converted to 12 Volt DC to recharge the house batteries.

Remote Control

A remote control located above the entry door allows you to customize the operating parameters of the inverter/charger, thus maximizing performance and increasing the life of the batteries. The remote also controls all of the operating and programming functions. The inverter/charger owner's manual outlines all of the functions in an easy to use format.

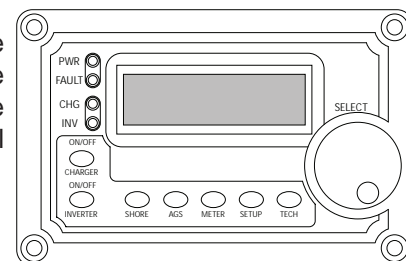

The following is a brief overview of the remote control:

Rotary Knob: Used to move between menus to select program options. Turn clockwise to increase selections and counterclockwise to decrease selections. Push the knob to “save” the selection displayed in the LCD screen.

Inverter ON/OFF: Used to switch the inverter function ON and OFF. The green “INVERTER” LED turns ON and OFF with the switch.

Charger ON/OFF: Used to switch the charger function ON and OFF. The green “CHARGER” LED turns ON and OFF with the switch.

 **Note:** For more information refer to the manufacturer's operation's manual.

SOFT KEYS:

Press the soft keys to access the required function. Then use the rotary knob to scroll through the selections. Press the rotary knob to save the selection.

Options include:

- > **Shore:** Sets the appropriate breaker size for the incoming shore power and is used to control the amount of AC amps the battery charger uses from HOT 1 IN. Selection options are 5, 10,15, 20, 30, and 50 amps.

- > **Setup:** Configures the inverter/charger.

Options include:

- **Search:** Used to set the watts at which the inverter will come out of sleep mode.
- **LBCO:** (Low Battery Cut Out) - Used to set the DC Voltage level to shut down the inverter to protect the batteries from over discharge.
- **Battery Size:** Used to select the approximate battery bank capacity.
- **Battery Charge Rate:** Used to set the maximum charge rate during bulk, absorption or float charge.
- **Battery Type:** Used to select battery type for the battery charge profile.
- **Contrast:** Used to adjust the LCD contrast.
- **AC Dropout Voltage:** Used to select the AC threshold (60, 90, and 100 Volt AC) where the inverter transfers from AC line to inverter mode.

 **Note:** Additional information for “SETUP” is in the manufacturer’s operation’s manual.

GROUND FAULT CIRCUIT INTERRUPTER

▲ WARNING

Even with GFCI protection, persons with severe heart or other health problems may still be seriously affected by an electrical shock. The GFCI outlet is not a substitute for good electrical safety. It DOES NOT protect against contact of the hot and neutral wire at the same time.

The 120 volt outlet in the kitchen and/or bath and outside receipts are equipped with a protective circuit interrupter. The ground fault circuit interrupter (GFCI), is designed to break the flow of current to the protected outlet when an imbalance of current is detected. Imbalances include electrical leakage in an appliance such as a shaver or hair dryer that have developed a weak spot in electrical insulation. The possibility of electrocution exists when using a faulty appliance, while at the same time being in contact with an electrical ground such as water, plumbing, or the earth.

If an imbalance is detected, the GFCI will trip and shut off power to the outlet.

It also does not protect against short circuits or system overloads. Circuit breakers in the main panel which supply power to the circuit, will trip if either of these conditions exist.

The GFCI receptacle should be tested initially when the motor home is purchased, and at least monthly thereafter.

To test the circuit, use the following procedure:

1. Make sure power is on to the circuit. A test light or 120 volt lamp will work.
2. Push the test button.
3. The red reset button should pop out.
4. All power should be interrupted to outlets protected by the GFCI.
5. Verify by plugging in a light at these outlets, and pushing in the reset button. If the red reset button does not pop out after pushing the test button, or GFCI circuit continues to trip, or if the power is not interrupted to the test light, immediately turn off power at the circuit breaker panel and have a qualified electrician check it out.

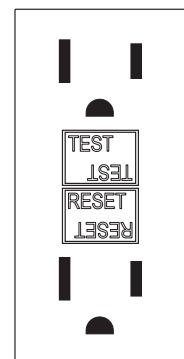



Note: The GFCI does not protect any circuit other than the one to which it is connected.

12 VOLT SYSTEM FUSES - GAS **GAS ONLY**

Interior

A 12 Volt DC distribution panel is located next to the 120 Volt circuit breakers. The panel contains circuits with replaceable fuses for protection of motor home 12 Volt lines. If any line is shorted, the fuse will "blow". Replace the fuse with the same size fuse. DO NOT replace with a larger fuse than indicated.

If this action does not solve the problem, there may be a "short" somewhere along the 12 Volt line, or at a non-fused 12 Volt component on the line. Check the 12 Volt line and any components along the line. Locate the "short" and take necessary steps to repair it. If you cannot locate the problem, have a qualified electrician check it out.

It is a good idea to keep additional fuses on hand in the motor home. Replacement fuses are available at filling stations, hardware stores, or automotive supply stores. Remember that the replacement fuse must be the same amperage rating as the original.

Automotive

Your motor home chassis is equipped with an automotive 12 Volt fuse panel located below the dash near the steering column and/or under the hood. You should refer to the chassis owner's manual for details on these fuses.

The Class A motor home also has a 12 Volt fuse panel, electrical distribution box, located on the fire wall under the hood. These fuses protect the automotive features which are installed by Four Winds International. There is a complete breakdown on the various fuses printed on the backside of this fuse panel cover. The class C fuse panel can be located under the bed, in the dinette base or kitchen base, depending on the model of your motor home.

CIRCUIT BREAKERS

The 120 Volt system is protected by circuit breakers which automatically shut the circuit off if the circuit load is too heavy, or a short circuit occurs. If a circuit breaker has been tripped, do not reset the breaker until the cause of the problem is identified and corrected.

The generator also has one or two AC circuit breakers, and a DC fuse on the generator control panel. If an interruption in generator operations occurs, check to see if any of these have been tripped. Consult the manuals provided with the generator before attempting maintenance on the generator.



Note: Some electrical appliances may have their own circuit breakers. If there is an interruption in electrical service of an appliance, consult the manual for that appliance to determine what action to take.

CLASS A AND CLASS C - GAS SYSTEM PANELS

 **Note:** Please use this information as a guide. Check your motor home for the sticker with the exact call outs.

110V For Units With 50 Amp Service

50	50	15	20	15	20	15	15	15	15	15	15
MAIN	MAIN	MICROWAVE	FRONT A/C	WATER HEATER	REAR A/C	TV RECEPTS	KITCHEN RECEPTS	GENERAL RECEPTS	CONVERTER	GFCI RECEPTS	OPT. CENTRAL VACUUM

110V For Units With 30 Amp Service And No Electric Water Heater

M	A	M	G	R	C
A	C	I	F	E	O
I		C	C	C	N
N		R	I	E	E
		O	S	R	
		W		T	
		A		E	
		V		R	
		E			
	20A	15A	15A	15A	15A

Converter Fuse Panel

NO	GA.	COLOR	ATC FUSE	POWER TO
1	14	RED	15 AMP	WATER PUMP
2	14	GRAY	15 AMP	DRIVERSIDE
3	14	VIOLET	15 AMP	PASSENGER SIDE
4	14	BLUE	15 AMP	REAR
5	14	ORANGE	15 AMP	APPLIANCES
6	18	ORANGE	5 AMP	MONITOR/LP & CO
7	12	BROWN	20 AMP	CEILING LIGHTS
8	14	YELLOW	15 AMP	MISC
9	12/14	PINK	15 AMP	AWNING
10	14	BLACK	15 AMP	MISC. LIGHTS
11	14	TAN	15 AMP	POWER POINT
12	12/14	GREEN	15 AMP	REAR AWNING

BCC Fuse Panel

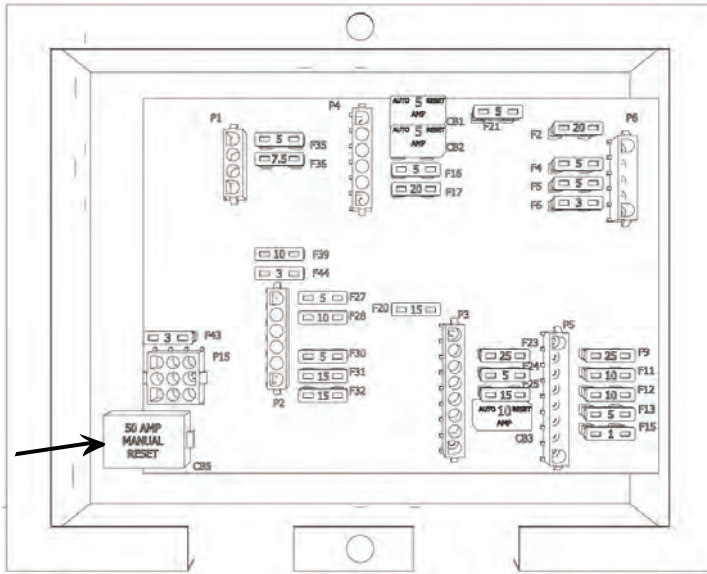

- P1-1 AUX START SWITCH
- P1-2 F35 RADIO
- P1-3 F36 ANTENNA BOOST
- P1-4 F39 RADIO MEMORY
- P4-1 CB1 DRIVER SHADE
- P4-2 CB2 PASS SHADE
- P4-3 F16 MAP LIGHTS
- P4-4 F17 POWER POINT
- P4-6 FOG LIGHT RELAY
- P2-1 F27 SOLAR PANEL
- P2-2 F28 O/S RADIO MEM
- P2-4 F30 OUTSIDE RADIO
- P2-5 F31 CARGO LIGHTS
- PS-6 F32 CARGO LIGHTS
- P3-1 F21 STEPS/AWNING
- P3-2 F20 FOG LIGHTS
- P3-4 F24 STEP SWITCH
- P3-5 F25 DOCK LIGHTS
- P3-6 CB3 DRIVER SEAT
- P5-1 ACCESSORY RELAY
- P5-2 F9 HVAC BLOWER
- P5-3 F11 DASH FANS
- P5-4 F12 MIRROR HEAT
- P5-5 F13 JACKS POWER
- P5-6 F15 MIRRORS
- P6-1 F2 SPARE
- P6-2 F4 JACKS DOWN
- P6-3 F5 TV CUTOFF
- P6-4 F6 REAR VISION
- P6-5 IGNITION RELAY

Note: Should you lose 12 Volt power inside your Class A gas motor home, there is a 50 Amp Reset Button in the Battery Control Center, located under the hood. Remove cover from the black box to access.

12 VOLT SYSTEM FUSES - DIESEL DIESEL ONLY

Inverter Bay Fuse Panel

The exterior 12 volt systems fuse panel is located in the inverter compartment bay. The six slots might not all be used, depending on equipped options.

12 VOLT				
#	GA	COLOR	FUSE	POWER TO
1	14	GREEN	15	DRIVER CARGO LIGHTS
2	14	YELLOW	15	PASS CARGO LIGHTS
3	14	ORANGE	15 BRKR	CORD REEL
4	10	RED	30	SYSTEMS HEAT
5	10	GRAY	15	FREEZER
6	18	RED/BLACK	5	COACH BATT SIGNAL

Bed Base Fuse Panel

#	GA.	COLOR	FUSE	CIRCUIT
1	14	RED	15	WATER PUMP
2	14	GRAY	15	DRIVERSIDE FRONT
3	12	VIOLET	15	FRONT CEILING LIGHTS
4	14	BROWN	15	PASS SIDE REAR
5	14	BLUE	15	DRIVERSIDE REAR
6	14	ORANGE	15	APPLIANCES
7	18	RED	5	RADIO
8	16	GREEN	7.5	TV BOOST/SATELLITE
9	18	ORANGE	5	MONITOR/CO & LP DET
10	14	PINK	15	AWNING
11	14	BLACK	15	PASS SIDE FRONT
12				
13				
14				
15				

DASH FUSES

The dash fuse panel is located under the dash on the wall. A circuit board with blade type fuses and breakers will be visible. The fuse and breaker locations are labeled below.

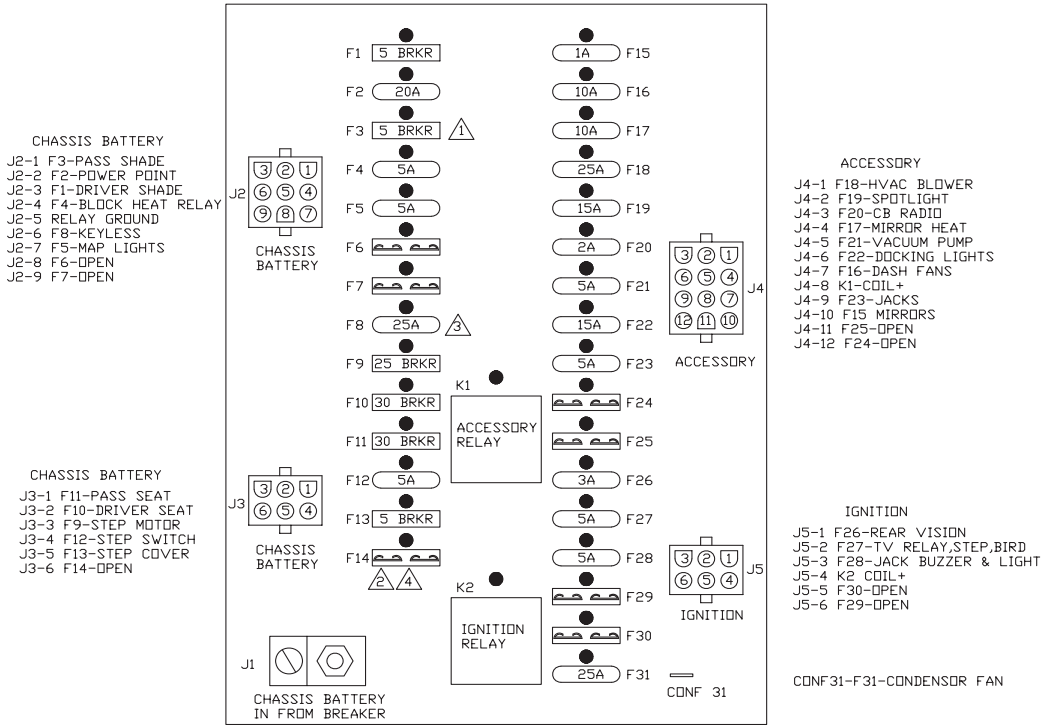

CHASSIS ALTERNATOR

The automotive chassis 12 volt system alternator supplies power to both the automotive systems as well as any auxiliary battery and directly to the motor home living quarters while the vehicle's motor is running.

The alternator compensates for electrical usage in the vehicle, the power drawn by the appliances, lights, fans and other 12 volt powered items as well as the charging of the automotive and auxiliary batteries.

If the alternator isn't keeping pace with the draw on the unit's electrical system, while driving down the road, it means you're working in a negative mode: more power is being used than the unit is putting out.

This means that you are taking power out of the batteries. If you draw too much power from the batteries there may not be enough power left in the battery to start the motor home or run any of the appliances when you stop for a break or for the night.

The alternator will charge at a higher rate right after the vehicle's been started, replacing the power used to start the vehicle, but the charging should quickly go back to "normal" and hold its own even when you turn on lights or appliances.

When stopped at a campsite that allows you use of the shoreline, the 120 volt electrical system will recharge your auxiliary battery.

Under heavy usage in warm weather, check the fluid level of those batteries that require attention to fluids quite often. Low battery fluid level is very harmful to the battery's longevity.

If the alternator shows a discharge while the motor is running, turn off appliances and lights to see if a charge comes on or if the alternator indicates "neutral". Then apply a drain on the system to see if a discharge returns. If a discharge persists, contact your dealer.

GENERATOR

⚠ DANGER CARBON MONOXIDE IS POISONOUS AND CAN CAUSE UNCONSCIOUSNESS AND DEATH.

 **Note:** Make sure to read and understand the generator owner's manual before operating the generator. Observe all operating instructions and warnings as well as all recommended maintenance schedules and procedures.

The onboard generator allows the motor home to be fully self-contained. It provides access to 120 Volt A/C when shore power is unavailable, but keep in mind that when in use the generator exhausts deadly carbon monoxide gas! NEVER sleep in the motor home with the generator running! Before you start and use the generator inspect the exhaust system. Do not use the generator if the exhaust system is damaged. Test the carbon monoxide detector every time you use the motor home. Know what the symptoms of carbon monoxide poisoning are:

- Dizziness • Vomiting • Nausea • Muscular twitching • Intense headache
- Throbbing in the temples • Weakness and sleepiness • Inability to think coherently

If you or anyone else experience any of these symptoms get to fresh air immediately. Shut the generator down and do not operate it until it has been inspected and repaired by a professional. If the symptoms persist seek medical attention!

1. **DO NOT** operate the generator while sleeping. You would not be aware of exhaust entering the motor home, or alert to symptoms of carbon monoxide poisoning.
2. **NEVER** store anything in the generator compartment. Always keep the compartment clean and dry.
3. **DO NOT** operate the generator in an enclosed building or in a partly enclosed area such as a garage.
4. **REVIEW** the safety precautions for fuel and exhaust fumes elsewhere in this manual.
5. **DO NOT** operate the generator when the motor home is parked in high grass or brush. Heat from the exhaust could cause a fire in dry conditions.
6. **NEVER** operate the chassis or generator engine, or the engine of any vehicle, longer than necessary when the vehicle is parked.
7. **DO NOT** simultaneously operate generator and a ventilator which could result in the entry of exhaust gas.
8. When parked, position the motor home so that the wind will carry the exhaust away from the motor home. **DO NOT** open nearby windows, ventilators, or doors into the passenger compartment, particularly those which can be "down wind", even part of the time.
9. **DO NOT** operate the generator when parked in close proximity to vegetation, snow, buildings, vehicles, or any other object which could deflect the exhaust under or into the motor home.
10. **DO NOT** touch the generator when running, or immediately after shutting off. Heat from the generator can cause burns. Allow the generator to cool before attempting maintenance or service.

The generator draws fuel from the motor home chassis fuel tank. The fuel supply line for the generator is placed higher in the fuel tank than that of the fuel supply line for the chassis engine, this prevents the generator from draining all the fuel from the fuel tank.

 **Note:** Some models may require you to plug the 30 amp shoreline into the generator outlet provided in the shoreline storage compartment.

To start the generator locate the generator start switch, which is located at one of the following locations:

- Generator Control Panel
- Kitchen Base Cabinet
- Remote Dash Switch

WATER SYSTEMS

The motor home plumbing system has the dual ability to be self-contained with on-board storage, or use facilities provided by an external pressurized source. In either case, the components of the system operate like those in your home. Components of the plumbing system consist of strong, lightweight, corrosion-resistant materials that provide long life, and easy cleaning. By following the instructions outlined here, you can expect efficient operation with a minimum of maintenance.

Motor home plumbing can be divided into two separate systems. The fresh water system consists of those items which are used to deliver water for your use, while the waste water system is made up of the drains and tanks which store and remove water that has been used.

FRESH WATER SYSTEM

Fresh water is provided from an external pressurized source, or from the fresh water storage tank.

External Hook-up

Water provided from outside the motor home is pressurized by the system from which it is delivered. When you connect your motor home to an outside source, the fresh water tank and the water pump are kept separate from the remainder of the system by in-line check valves.

To connect the motor home to an outside source of water:

1. Remove the cap from the fresh water inlet on the side of the motor home and attach one end of the fresh water hose to the outside source of water.
2. Connect the other end of the hose to the motor home city water inlet.
3. Turn the outside source of water ON and open the various faucets in the motor home gradually to clear the air from the lines. Close the faucets when the water flows freely.

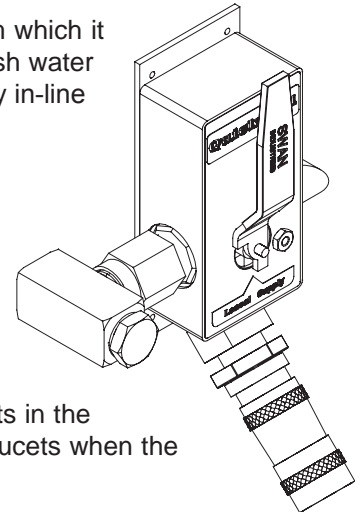

 **Note:** Do not turn the water pump on when using water from an external supply.

To disconnect from the outside source of supply:

1. Shut off the outside source of water and disconnect the hose from the valve and vehicle inlet.
2. Re-reel the hose and reinstall the cap on the motor home inlet.

Fresh Water Tank With Gravity Fill

When an outside source of water is unavailable, water can be drawn from the fresh water storage tank for use in the motor home. The tank is filled through a gravity controlled water fill spout on the side of the motor home.

To fill the fresh water tank:

1. Remove the water fill spout cap and fill directly to the tank.
2. Use a clean hose or bucket from a clean, safe source of water.
3. Be sure to replace the fill spout cap after the tank is filled.

 **Note:** Never leave the hose unattended while you are filling the fresh water tank.

 **Note:** Water will overflow through the vent located at the top of the fresh water tank if the tank is filled beyond capacity.

When traveling, you may want to drain the tank, or keep the quantity of water in it to a minimum. This reduces the total weight of the motor home for travel. Make sure when draining the tank, that the water pump has been turned off. The fresh water tank drain valve is located below and near the fresh water fill spout. Water in the tank can be drained by turning the drain cock perpendicular to the motor home body. To close the valve, turn the lever parallel to the motor home body.

 **Note:** When trying to drain the entire on-board fresh water system, make sure to open faucets, water heater drain, and system low point drains to remove all fresh water from the system.

Fresh Water Tank Without Gravity Fill

When an outside source of water is unavailable, water can be drawn from the fresh water storage tank for use in the motor home.

To fill a fresh water tank:

1. Attach a potable water hose to the inlet inside the water systems panel area, and an outside water supply.
2. Turn the lever on the by-pass valve to the fresh tank position and begin filling.
3. When the tank is full turn off the water supply. View reading on the monitor panel.

 **Note:** Never leave the hose unattended while you are filling the fresh water tank.

 **Note:** There is an overflow vent located at the top of the fresh water tank. If the tank is filled beyond capacity water will flow out through this vent onto the ground.

 **Note:** Always fill the tank with clean potable water from a known safe source. Make sure to close the fill spout when the tank is filled.

Water Pump

When using water from the fresh water tank, the system must be pressurized. A self-priming 12V DC pump is provided to handle this function. A pump ON/OFF switch is located on the monitor panel.

When initially starting up the self contained water system, follow this procedure:

1. Make sure the tank is filled with water.
2. Open all the faucets in the motor home, both hot and cold.
3. Place the pump control switch in the ON position.
4. Allow time for the hot water tank to fill. Shut off each faucet as the flow becomes steady and free of air. When the last faucet is shut off, the pump should also shut off.
5. The system is now ready for use.

 **Note:** When filling the system, you may want to add additional water to the tank to replace the water used when filling the hot water tank and water lines.

The self contained water system is a demand system. This means that the water pump will run whenever there is a need for water. If the pump runs while all faucets are closed, there may be a leak in the system. Ask your dealer for assistance.

 **Note:** The low point drains are located in the water lines on the floor of the motor home except the Windsport and Diesel brand motor homes. Specific locations along the water lines will vary depending on the model of your motor home. The low point drains for the Windsport and Diesel models are the outside shower which is located in an exterior compartment, below the floor.

Sanitizing the Fresh Water System

Sanitize the system before initial use, after extended periods of non-use, at least once a year during continuous use, and whenever there is suspicion that the system has been contaminated.

To sanitize the system with a gravity fill, use the following procedure:

1. Prepare a chlorine solution using a gallon of water and ¼ cup of liquid household bleach (5% sodium hypochlorinate solution). Use one gallon of solution for each 15 gallons of tank capacity.
2. With tank empty, and all faucets and drains closed, pour the solution into fresh water tank.
3. Complete filling the tank with fresh water.
4. Switch on the water pump. Open all faucets one at a time until all air is purged, and the water flows freely.
5. Again add fresh water to the tank until the water level reaches the fill spout.
6. Drain the system by opening all faucets, and the fresh water tank drain valve, while flushing the system with water of drinking quality.
7. Continue flushing the system, allowing the water to flow for several minutes.
8. Close the tank drain valve and faucets. Refill the system with water of known drinking quality.



Note: A slight chlorine taste may linger. If this is objectionable, mix a solution of 1 quart Vinegar to 5 gallons of water and add to the tank. Repeat process above, but without the bleach.

To sanitize the system without a gravity fill, use the following procedure:

Items needed:

- 1 - Battery powered drill (do not use an electric drill)
 - 1 - Drill powered water pump
 - 1 - 5 gallon bucket to prepare solution
 - 2 - 4 foot sections of ½ inch inside diameter hose
 - 2 - Female hose ends for ½ inch hose with ¾ inch threaded end (compression style)
 - 1 - Male hose end for ½ inch hose with ¾ inch threaded end (compression style)
 - 1 - 1 cup of household bleach
1. Install one male and one female hose end to one of the 4 foot sections of hose. When completed, the section of hose will have a male hose end on one side and a female hose end on the other side.
 2. Connect this hose to the outlet side (usually marked with an arrow) of the pump. The other end of the hose will get connected to the city water fill on the coach. Prior to attaching the hose to the city water fill, remove the pressure regulator first, otherwise the pump will not be able to push the water past the regulator. The hose will attach to where the regulator use to be.
 3. Install one female hose end to the other 4 foot section of hose.
 4. Connect this hose to the inlet side of the pump. The end of the hose that does not have hose end will go into the five gallon bucket to pump out the sanitizing solution.
 5. Fill the bucket half full with water and add one cup of household bleach. Attach battery drill to the pump making sure that the drill rotation matches the rotation needed to work the pump.
 6. Using the drill, pump the solution from the bucket into the fresh water tank until solution is gone. Remove the pump/drill apparatus and complete filling the tank with water.
 7. Switch on the water pump. Open all faucets one at a time until all air is purged, and the water flows freely. Once the tank is half empty turn off the water pump.
 8. Again, add water to the tank until it is full. Allow the system to stand undisturbed for at least 15 minutes.
 9. Turn the water pump on to drain the system by opening all faucets, and the fresh water tank drain valve, while flushing the system with potable water.
 10. Continue flushing the system, allowing the water to flow for several minutes, and then turn off the water pump. Close the tank valve and faucets. Refill the system with potable water.

MONITOR PANEL

The monitor panel allows you to quickly check the levels in the fresh water and waste water tanks. Electrical sensors at various points on the tanks send signals to the monitor panel. To check fluid levels, press and hold the test switch designated for the tanks, and read the level indicators on the panel. The indicator is proportioned in thirds with each light being lit up to the level that the tank contains.

Sometimes, residue on the sides of a tank, or water with a low mineral content will give a false reading. Check the levels occasionally when you are sure of a tank's contents to double check the accuracy of the monitor panel.

Tank Capacities

The monitor panel allows you to quickly check the levels in the fresh water and waste water tanks. Electrical sensors at various points on the tanks send signals to the monitor panel. To check fluid levels, press and hold the test switch designated for the tanks, and read the level indicators on the panel. The indicator is proportioned in thirds with each indicator light illuminating to the level that the tank contains. Indicator lights and their meanings:

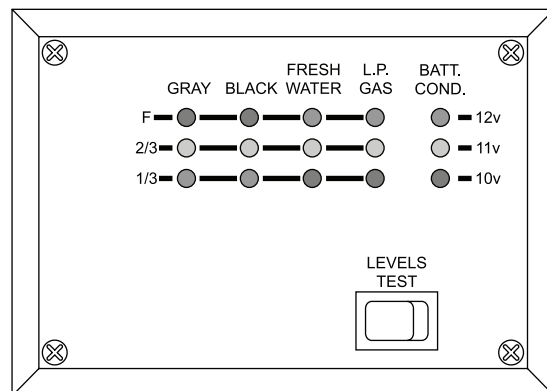

Inaccurate Holding Tank Level Readings

The accuracy of two wire holding tank monitoring systems can be adversely affected by dirty tanks or unusual mineral content in the water. These conditions can cause the monitoring system to have oversensitive (reads higher than actual level) or under sensitive (reads lower than actual level) readings.

Over Sensitive Readings

Oversensitive readings can occur as a result of scum build up on the tank walls, or abnormally high mineral content in the water. In these situations, the monitoring system indicates higher levels than are actually present in the holding tank. Certain cleaning products and food by-products can build up on the inside walls of the holding tanks, producing a layer of scum that can cause the monitoring system to read higher than the actual level. To correct this problem, the holding tanks should be cleaned periodically (consult dealer for cleaning instructions).

Under Sensitive Readings

Under sensitive readings can occur if the mineral content of the water is abnormally low. In this case, the monitoring system indicates lower levels than are actually present in the holding tank. This problem can be corrected by moving the ground probe closer to the other probes.

WASTE WATER SYSTEM

The waste water system in the motor home can be described as two separate systems. A gray water system that consists of the drain lines and holding tank for waste water from the sinks and tub, and a black water system which includes the holding tank and drain for toilet wastes. In some cases the bathroom lavatory may drain into the black tank to make sure there is adequate water to prevent solid build up. Each system is self-contained, and allows disposal of waste water at designated dump stations at your convenience.

Components of the gray water system have drain traps, and both tanks are vented to equalize air pressure and disperse odors caused by drain water and wastes outside. Sometimes, the rocking movement of the motor home while driving may empty the drain traps of their water, and allow the odors of the gray water tank to come into the coach. Residue in the drain water lines can also produce odors. To combat gray water holding tank odors, an approved deodorizing agent should be used. An agent that dissolves grease and fats and contains a detergent will help keep tank and drain lines clean and free-flowing.

Holding Tanks

⚠ WARNING MOST CHEMICAL MIXTURES FOR HOLDING TANK ODOR CONTROL ARE POISONOUS. FOLLOW THE PRODUCT MANUFACTURER'S DIRECTIONS AND WARNING WHEN USING ANY HOLDING TANK ADDITIVE.

Drain valves and drain hose storage are located on the driver's side. Each tank has a separate drain line and dump valve, which permits dumping tanks individually or together. Each tank should be emptied at a dump station designated for this purpose. Most national, state, and private campgrounds have dumping facilities. Many have hookups on the campsite, while some have portable dump collectors. Many service stations, particularly along interstate highways, also have these facilities. Many campground directories list dumping station locations across the nation.

If possible, dump holding tanks before a trip, to reduce the gross vehicle weight. Enough water should be kept in the black water tank to cover the bottom, to prevent hardening of any residue that may remain.

Do not dump black water tank until it is 3/4 full. This practice makes sure that enough water is in tank to flush all wastes into sewer lines. If necessary, fill tank to the 3/4 mark with additional water before draining.

Never put anything in the holding tanks other than normal drain water, wastes, and biodegradable products. Paper wrappers, gum, cigarettes, etc., no matter how small they may be, should never be placed into either the gray or black tanks.

 **Note:** It is important to note that harmful and toxic materials can accumulate if the holding tanks are not regularly drained and thoroughly rinsed. It is also important to use holding tank deodorizing and cleaning agents in the waste water tanks to reduce odors and keep the lines open and free-flowing.

 **Note:** The diagram below shows a typical waste water system termination valve layout.

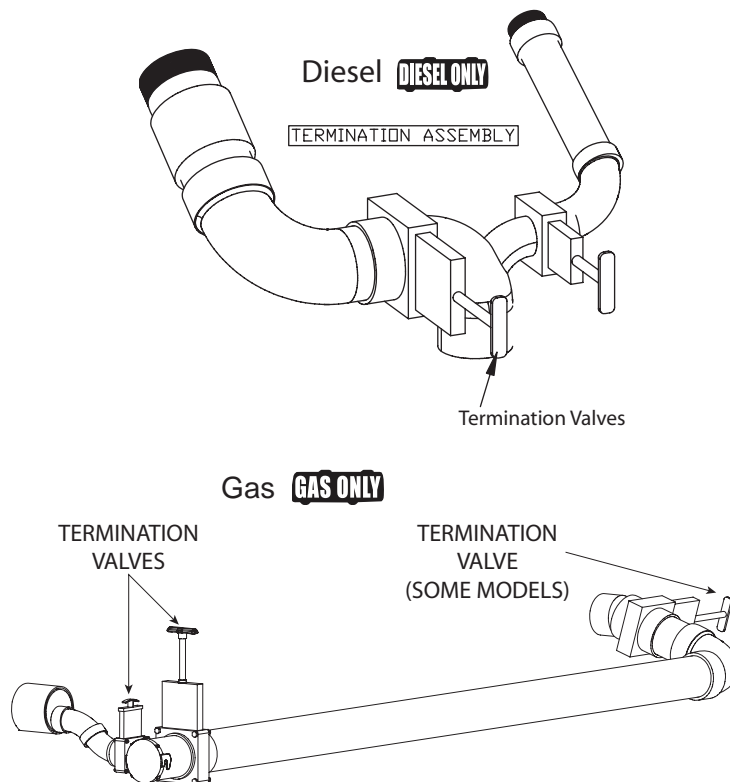



Emptying the Holding Tanks

1. Remove the sewer drain hose from its storage compartment on the side of the coach.
2. Remove the cap from the sewage drain, and connect the drain hose to it.
3. Attach the other end of the flexible drain line to the dump station inlet. Make sure both ends of the flexible drain line are securely attached.
4. Drain the black water tank first, by pulling the termination valve handle toward you. Make sure to allow sufficient time for the tank to completely drain, then rinse the tank with several gallons of water by depressing the stool pedal. Close the valve on the stool and let it fill before releasing the tank. This creates additional force to flush the tank more completely.
5. Drain the gray water tank by pulling the termination valve handle toward you. Draining the gray water tank last, with its soapy water helps to further rinse the drain and flexible hose,
6. When tanks are emptied, close termination valves by pushing handles back to closed positions.
7. Remove flexible drain hose and wash it thoroughly with clean water. Remove the other end from the dump station inlet, and replace it in its storage compartment. Secure the sewer hose storage cover, and replace the caps on both the motor home outlet and dump station inlet.

The following guidelines will help to ensure trouble free operation:

- Never put anything in black water tank other than toilet paper especially for motor home systems.
- Do not put automotive antifreeze, household toilet cleaners or drain cleaners, or any solid material into the waste water system.
- Always use chemicals in the black water system that are made especially for this purpose.
- When cleaning components of waste water system, use cleaners made for motor home systems.
- Always keep the drain cap in place, and termination valves closed.
- After every third time the holding tanks are emptied, fill and flush both tanks with clean fresh water a couple of times to keep them clear and clean.

 **Note:** If connecting to a campsite sewer inlet, DO NOT open termination valves until tanks are 3/4 full. DO NOT keep black water valve open while parked. Wastes are NOT flushed directly into sewer system. Only liquid waste is drained, therefore, water must accumulate, and chemicals in tank need time to break down solids before they can be released. If draining gray water tank directly into sewer inlet while parked, make sure to close termination valve for a period of time before leaving, allowing some water to accumulate in tank to use for flushing drain line and flexible hose.

 **Note:** Always remember to clean up the dump site before leaving. NEVER empty your holding tanks directly on the ground, a roadway, river or stream. DO NOT POLLUTE.

TOILETS

The toilet installed in the motor home is connected to the pressurized fresh water system. The two most common style of toilets use either a foot pedal or hand lever to flush and add water to the bowl.

Hand Lever Style:

To flush the hand lever style, pull the lever forward (clockwise) until rinse clears the bowl. Be sure to release the lever slowly. Movement of the flush lever opens the waste valve and allows the water to pass into the holding tank.

To add water to the bowl, pull the lever forward (clockwise) approximately half way. This will open the water valve and leave the flush lever closed.

ADD WATER

FLUSH

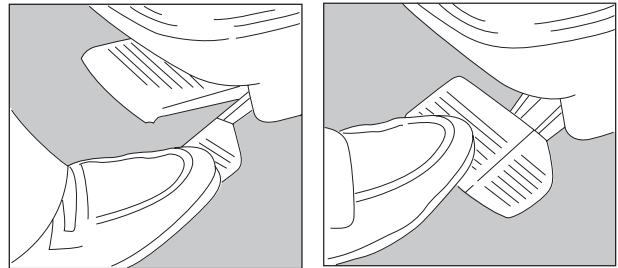



Foot Pedal Style:

To flush the foot pedal style, depress the large pedal on the left hand side until rinse clears the bowl. Be sure to release the lever slowly. Movement of the flush lever opens the waste valve and allows the water to pass into the holding tank.

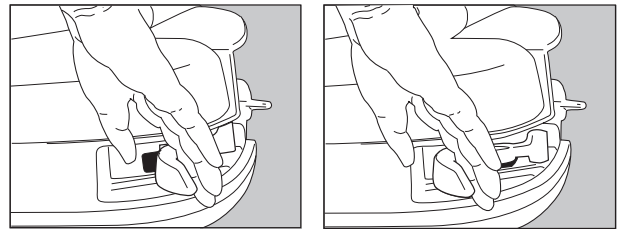
To add water to the bowl, depress the small pedal on the right hand side. This will open the water valve and leave the flush lever closed.



 **Note:** Unnecessary frequent flushing of the stool will quickly deplete your fresh water supply and fill your holding tank. If the black water tank becomes full, you will no longer be able to flush the stool until the tank can be drained.

 **Note:** Follow the toilet manufacturer's recommendations supplied with the toilet for cleaning and maintenance. If you have a toilet that differs from the description given here, make sure to follow the manufacturer's advice for operation.

Aria Deluxe II

The Thetford toilet installed in the motor home is connected to the pressurized fresh water system. There are two flush modes available, controlled by the mode selector switch located at the back of the toilet. Up is user control/water saver mode and down is residential mode.

For residential mode touch the large button once and walk away. For user control mode hold down large button for as long as you'd like to flush. Unnecessary frequent flushing of the stool will quickly deplete your fresh water supply and fill your holding tank. If the black water tank becomes full, you will no longer be able to flush the stool until the tank can be drained.

If 12 Volt power is lost for some reason, turn the black knob on the rear of the toilet to flush.

TO FLUSH

Residential Mode
Touch once and Walk-Away™



User Control Mode
Hold down button for as long as you'd like to flush



DOWN



Switch located at back of toilet

UP





Add Water
Hold down small button



- Either mode -

For cleaning or tank maintenance:
Keep valve open by pressing both buttons twice





Operation (Continued)



Back of Toilet

Manual override

In the event of a power outage, the contents of the bowl can be released to the holding tank by opening the valve manually using the override knob on the back of the toilet. Turn clockwise to open, counter-clockwise to close.

TECMA Toilet

The Tecma toilet is connected to the pressurized fresh water system, and has two flush modes available. Unnecessary frequent flushing of the stool will quickly deplete the fresh water supply and will also fill the holding tank. If the black water tank becomes full, you will no longer be able to flush the stool until the tank can be drained.

- **Water Saver Flush:** Press and release the button to flush liquids.
- **Normal Flush:** Press and release to flush solids and toilet paper.
- **Empty Bowl:** Press both buttons simultaneously and release to empty bowl and leave it dry for travel. Press either button once to return to normal use.

 **Note:** The TECMA toilet operating instructions are located on a label on the underside of the seat cover. Refer to this label when programming the water level.

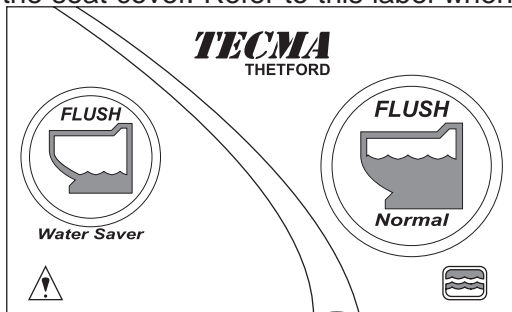

WATER SYSTEM WINTERIZATION

If you intend to store your motor home through periods of subfreezing weather in an unheated environment, it will be necessary to winterize the water system. Damage to water system components will result if proper winterization steps are not taken:

 **Note:** Four Winds recommends this be done by a qualified technician or dealer.

Class A Water System Winterization

1. Level the unit for good system drainage.
2. Drain the waste water tanks (black then grey following drainage guidelines) and fresh water tank.
3. Turn the water pump switch off.
4. Open all faucets, and water heater drain.
5. Open low point drains on the water lines, including the outside shower.
6. When all lines are drained, close water tank valve, all faucets, water heater drain, and low point drains on water lines.
7. Turn water heater bypass valve on to prevent tank from filling with antifreeze.
8. Remove water filter (if installed) and replace with bypass cap to protect filter.
9. If unit is equipped with an ice maker, turn off the water valve.
10. Position antifreeze so siphon hose can be connected to the winterizing connection.
11. Turn valve to position which will allow the water pump to pump from antifreeze container.
12. Turn on the water pump and let each faucet run until antifreeze flows freely from both hot and cold lines. Also run the shower and toilet until antifreeze is visible.
13. If unit is equipped with a washer/dryer turn on and let run until antifreeze is visible and continue to run for 15-20 seconds. Turn cycle selector to rinse cycle to ensure the antifreeze gets into the pump to protect it.
14. Turn off water pump.
15. Pour one cup of antifreeze in every drain to protect the P-traps.

Class C Water System Winterization

1. Level the unit for good system drainage.
2. Drain the waste water tanks (black then grey following drainage guidelines).
3. Turn the water pump switch off.
4. Open all faucets, and water heater drain.
5. Open low point drains on the water lines (pull up and twist valve) and the outside shower to let water drain.
6. Drain the fresh water tank using outside spigot type drains.
7. When all lines are drained, close water tank valve, all faucets, water heater drain, and low point drains on water lines.
8. Turn water heater bypass valve on to prevent tank from filling with antifreeze.
9. Remove water filter (if installed) and replace with bypass cap to protect filter.
10. Remove water pump line at fresh water tank location and attach siphon hose to fitting.
11. Turn on water pump and let each faucet run until antifreeze flows freely from both hot and cold lines. Also run the shower and toilet until antifreeze is visible.
12. Turn off water pump.
13. Pour one cup of antifreeze in every drain to protect the P-traps.

Before using the system again in warmer weather, completely flush the system with water, flush the toilet, and sanitize the entire fresh water system. When using the motor home during cold weather and water in a tank or drain line should happen to freeze, you should take immediate steps to thaw it before damage to the system occurs. DO NOT continue to use water system components if such a condition exists. If damage has occurred, make sure to have it repaired before using again.

WATER SYSTEM MAINTENANCE

As with any mechanical system, your plumbing is subject to the development of problems. Most of these problems can be greatly reduced if not altogether eliminated by following a schedule of planned inspections and maintenance. Neglect of proper maintenance procedures is the usual cause of most water system problems.

Road vibrations and shocks, as well as excessive pressure from some city water sources are the main physical causes of water system damage. It is important to inspect all plumbing joints and fittings often for cracks and leaks. Water leaking from a plumbing joint can cause considerable damage if left unchecked.

A leak somewhere in the fresh water system should be suspected whenever the pump is running and all faucets and valves are closed. When the leaking fitting has been identified, attempt to stop the leak by tightening. DO NOT over tighten. Plastic fittings rarely need to be tightened with a wrench. If these fittings leak after tightening by hand, disconnect the fitting and check for dirt, scale, or other foreign substances which may be causing the leak. Clean the fitting thoroughly and reinstall. If leaking persists, shut off the water supply until the fitting can be properly replaced. Check with your dealer for correct method of replacement, and replacement parts.

Proper winterization procedures of plumbing systems will normally be all that is necessary to prevent the damage caused by freezing. Freezing damage can harm any component of the system, including the water tanks, toilet, pump, and all piping. Be sure to follow the winterization procedures outlined in this manual. Also be sure to discuss any additional precautions that should be taken to winterize your motor home's plumbing system with your dealer. Local climates vary; and winter maintenance needs may be effected.

Be sure to read the literature supplied with plumbing components, such as the pump, for troubleshooting tips. Also remember that it is possible for an electrical problem to cause water system problems. Lack of power to the pump can be caused by a variety of reasons. If you are unsure of how to locate and or repair a plumbing problem, it is best to have your dealer or a qualified plumber handle the job.

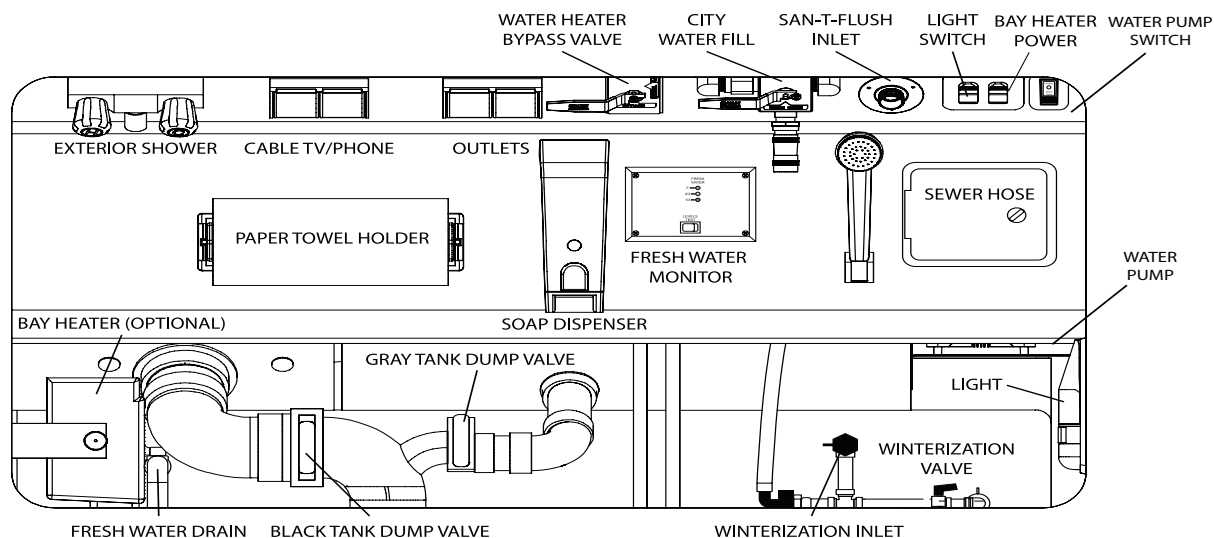
SYSTEMS COMPARTMENT - DIESEL **DIESEL ONLY**

Exterior Shower: Provides hot or cold water to the exterior of the motor home.

Cable/TV/Phone Jack Hook-up: When available, provides cable and or satellite to interior of motor home.

120 Volt Outlets: Provides 120 volt electricity to the exterior of the motor home.

Water Heater Bypass Valve: Diverts water flow around the water heater for winterization process.

City/Fresh Tank Water Fill Valve: Two way directional valve which controls city water between filling the fresh water tank and direct interior usage.

San-T-Flush Inlet: Used to clean the black and gray holding tanks of waste and debris.

Compartment Light: Provides power to the compartment light.

Water Heater Switch: Provides power to the water heater.

Water Pump Switch: Provides power to water pump.

Sewer Hose Storage: Place the sewer hose here when not in use.

Fresh Water Tank Monitor Panel: Check the fresh water tank level by pressing the level test switch.

Liquid Soap Dispenser: Fill with soap for easy clean-up after working within the compartment.

Paper Towel Holder: Fill with paper towels for easy clean-up after working within the compartment.

Bay Heater (Optional): Used to maintain compartment ambient temperature above freezing.

Fresh Tank Drain Valve: Turn handle to the left to drain excess water from the fresh tank.

Black Tank Dump Valve: Pull T-handle out to dump solid waste from the black tank.

Gray Tank Dump Valve: Pull T-handle out to dump waste water from the gray tank.

Winterization Inlet: Antifreeze inlet for winterization.

Winterization Valve: To winterize, rotate the handle on the valve so that it is perpendicular to the water line. Refer to winterization procedure for winterizing.

PROPANE GAS SYSTEMS

⚠ DANGER PROPANE GAS IS HIGHLY VOLATILE AND EXTREMELY EXPLOSIVE. Do not use matches or a flame to test for leaks. Use only approved Propane gas leak testing solutions for leak detection. Unapproved solutions can damage copper tubing and brass fittings. Never attempt to adjust propane gas regulators. Only qualified personnel should perform any maintenance or repair to the propane gas system.

The propane gas system furnishes the fuel for cooking, heating, and hot water. Propane gas can also be used as an alternate energy source for refrigeration. Propane is a clean, efficient, safe form of energy when proper handling and safety precautions are observed.

The Propane Gas system is designed to accept either Propane or Butane. However, since Butane vaporizes at about 32°F, it can only be used in areas where you can be sure of higher temperatures. Propane vaporizes at approximately -40°F. There are blends of Propane and Butane available, which will vary in the temperature at which it vaporizes. When filling the tank, select a Propane Gas that has a boiling point about 40° lower than temperatures you expect to travel in. Consult with your dealer, or local Propane Gas supplier about what you should be using.

PROPANE GAS TANK

The gas is stored under extreme pressure in the tank, with space in the tank to allow for expansion into vapor. This vapor is reduced in pressure by passing through a regulator. This reduction in pressure is a two step process which assures consistent pressure for use, regardless of outside temperatures, weather, or altitude.

 **Note:** For detailed information regarding propane gas and it's use, consult a qualified propane service representative.

Filling the Tank

⚠ WARNING MAKE SURE THAT THE TANK IS NOT FILLED BEYOND THE 80% LIQUID LEVEL. Even though the tank is equipped with an automatic 80% shut-off which prevents over-filling beyond 80% tank capacity, it is a good idea to have the supplier monitor the 20% liquid gauge, and stop the filling process if liquid does appear. If the tank has been over-filled, make sure the Propane supplier bleeds out the excess. Over-filling the propane gas container does not allow for the necessary 20% vapor expansion space that can result in uncontrolled gas flow which can cause a fire or explosion.

 **Note:** Make sure the tank service valve is accessible at all times. In an emergency, it may be necessary to shut off the valve quickly.

1. Before entering the propane bulk plant or service station, make sure all pilot lights are extinguished. Shut off gas to all appliances by first turning off each appliance, then close the propane gas main shut-off valve.
2. Extinguish open flames and smoking materials.
3. Never remove the propane gas tank from the motor home. Always drive the motor home to the gas supplier to fill.
4. Have the supplier connect the fill nozzle to the tank fill connection.
5. Always remember to close the supply valve, and open the 20% liquid level valve.

6. Never use a wrench to close the service or the 20% liquid level valve. If when closing by hand, leaking occurs, have the valve repaired or replaced.
7. Drive at least one mile from the propane gas supplier before relighting pilot lights or appliances. This will allow any minimal leakage which occurred while filling the tank to dissipate. DO NOT light pilot lights if you continue to smell propane gas. Shut off the Supply Valve. Allow the motor home to ventilate for 30 minutes. If you still detect propane odor, have the source of the leak located and repaired.

Never use any other tank than the one furnished with the motor home. If the tank must be replaced, check with your dealer for correct tank specifications and replacement procedure.

Propane Gas Regulator

⚠ WARNING NEVER ALTER THE POSITIONING OF THE REGULATOR. Propane gas regulators must always be installed with the diaphragm vent facing downward. Also make sure to keep the regulator cover in place to minimize vent blockage which could result in excessive gas pressure causing fire or explosion. Do not rely upon being able to smell propane gas leaks, as the odor may not be sufficiently strong enough to detect.

The regulator reduces the pressure of the propane gas vapor from the pressure in the tank, to the pressure required for use at the appliances. This reduction in pressure is performed by a two-stage regulator. Two regulators are used in the same body to reduce the pressure of the propane gas in the tank for use by the appliances in the motor home. The regulator seldom requires service, but it should always be protected from the elements and extremes of hot and cold.

The high pressure regulator (first stage) is used to reduce the pressure to approximately 10 to 13 PSI before sending it along to the low pressure regulator (second stage). This second stage regulator reduces the pressure further to 11 inches water column, or 6.35 ounces per square inch. The two stages regulator does not have to work as hard since the second stage receives consistent pressure rather than inlet pressure which varies. The result is an efficient safer system that helps to eliminate problems such as freeze up and pilot outage.

The regulator has been preset by the manufacturer of the regulator, and adjustment should not be necessary. If adjustment should be required however, DO NOT attempt to adjust it yourself. Adjustment must be made with special equipment by a qualified propane gas service technician. Have the regulator checked annually, or whenever you suspect a problem. The correct line pressure should be 6 ¼ oz. or 11 inches of water column.

Because air is required for proper operation of the regulator, it is very important that the regulator vent is kept clean and free of dirt and debris. This is why it is necessary to keep the vent facing downward and the regulator covered to protect it from contamination. A toothbrush can be used to clean the vent if it becomes clogged by foreign matter.

Regulator Freeze-Up

During cold weather, it is important to keep ice from forming in the regulator, which will shut off the flow of propane gas to the appliances. Have the supplier add a hydrous Methanol when filling the tank for use during cold weather. Regulator freeze-up can occur in any weather if there is moisture in the tank, or if the tank has been over-filled. Always use moisture-free propane gas, and make sure the tank has not been filled beyond 80% of capacity. If moisture has entered the tank, have the tank purged, or have hydrous methanol added by an authorized propane gas supplier.

If you believe a regulator has been damaged or otherwise is not functioning, have it replaced by a qualified propane gas service representative.

The term regulator freeze-up is a misleading one. Regulators and propane gas do not freeze. However, the moisture that can be contained in the gas will freeze as the gas expands and cools passing through the regulator. This freezing of the moisture in the gas can build up and partially or totally block the passage of the gas through the regulator. Freezing can also occur when outside temperatures are low enough to contribute to the freezing of the moisture in the gas.

The source of the moisture is varied. It can occur at the refinery or gas bulk plant, in the rail cars used to transport the gas, or even within the motor home propane gas tank. Moisture in an propane gas tank can occur when a tank service valve is left open, allowing moist air to enter and become trapped.

A two-staged regulator helps to reduce the possibility of freeze-up because of its larger orifice size, and the fact that heat is transferred through the walls of two regulators instead of just one.

Take these steps to inhibit or prevent this from happening:

1. Make sure that the propane gas tank is free of moisture before refilling
2. DO NOT overfill the propane gas tank.
3. Make sure to keep the service valve on an empty tank closed.
4. If freezing has occurred, have your propane gas dealer purge the propane gas tank before refilling.
5. Add a hydrous methanol or other approved propane gas antifreeze or de-icing agent to the propane gas tank.
6. Keep the regulator covered at all times.



Note: **IF FREEZE-UP DOES OCCUR**, shut off the propane gas at the tank. A frozen regulator may permit propane gas to flow at high pressure, resulting in leaks at appliances or in the lines. If freeze-up does occur, NEVER attempt to thaw with an open flame. Once thawed, be sure to take the proper steps to prevent a reoccurrence. Have the system checked by your propane gas supplier if freeze-up continues.

Remember that as outside temperatures drop, the BTU value of the propane gas is lessened, since the colder liquid propane in the tanks requires the heat from the surrounding air to vaporize. This lowering of BTU value can significantly affect the performance of the system. You can help insure proper performance by keeping the propane gas tank as full as possible in cold weather, and reviewing the BTU/hr plates on propane gas appliances for proper propane management.

PROPANE GAS HOSES PIPES TUBES AND FITTINGS

The hoses, pipes, tubes, and fittings used in the propane gas system are designed to withstand pressures far exceeding those of the propane system. However, because environment and time can both contribute to the deterioration of these components, they must be inspected for wear at regular intervals. Be sure to inspect the hose before each season and when having the tank refilled. Look for signs of deterioration such as cracks or loss of flexibility. When replacing the hose or other propane components, make sure to always replace them with components of the same type and rating (check with your dealer).

PROPANE GAS SAFETY PRECAUTIONS

⚠ WARNING **DO NOT STORE PROPANE GAS CONTAINERS INSIDE THE Motor home.** Propane Gas containers are equipped with safety devices which relieve excessive pressure by discharging gas to the atmosphere. Failure to comply could result in explosion resulting in death or serious injury.

If you smell propane gas:

1. Extinguish any open flames, pilot lights and all smoking materials.
2. **DO NOT** touch any electrical switches.
3. Shut off the gas supply at the tank valve(s) or gas supply connection.
4. Open all doors and other ventilating openings. (**DO NOT USE THE RANGE HOOD**).
5. Leave the area until the odor clears.
6. Have the system checked by a trained professional before using again.

Be careful when doing any work or maintenance in the motor home, that you do not puncture a gas line with a nail, screw, or drill bit.

Warning labels and decals are used throughout the motor home in locations where the potential for a dangerous situation is present. They have been installed not only because of the requirement to do so, but also as a constant reminder to occupants of the motor home to exercise proper caution when using or being around propane gas appliances and equipment. Make sure that you and your family understand and follow all of them. Never remove these warning labels and decal's. If one should be lost, it should be replaced as soon as possible.

CARE AND MAINTENANCE

Periodic maintenance and cleaning of your motor home is necessary to retain the dependability, safety, and appearance that will provide you with many miles of trouble free operation, as well as protecting your investment.

Make sure to read and follow all the maintenance tips and schedules that appear not only in this manual, but also in the manuals provided by the chassis manufacturer and various component manufacturers. Keep good records of maintenance functions performed, and make sure to perform all owner obligations as may be required by the chassis manufacturer to keep your warranty in force.

It is also important to note that operating conditions will effect service timetables. Driving in extreme conditions such as heavy dust, continuous short trips, or start and stop heavy traffic means that service durations will be shortened. Discuss service timetables with both your dealer and chassis service representative. Preventative maintenance will pay for itself many times over by catching or preventing problems before they occur. Many repair costs are greatly increased due to the fact a small problem can begin to effect other parts and systems of the motor home if left unattended.

If a situation arises involving a maintenance or cleaning activity for which you are not sure of the proper procedure, do not hesitate to contact your dealer, or chassis service representative for information.

 **Note:** Performing periodic maintenance is not covered under the Four Winds Limited Warranty.

FIBERGLASS SIDING

The care of fiberglass siding is essentially the same as any automotive finish. Wash your motor home at least once a month. Use warm water and a mild detergent to clean the finish. Take care to avoid spraying water directly into refrigerator and furnace vents when washing the motor home. Remove bird and tree sap droppings, insects, and tar as soon as possible to avoid staining of the finish.

It is important to note that any finish will deteriorate with time. Dulling and fading can be increased by exposure to extreme sunlight, air pollutants, and excessive moisture. Surface weathering of fiberglass does not change the strength of the fiberglass. Regular washing and waxing of exterior surfaces is the best insurance against surface deterioration such as fading, yellowing, or chalking. If surface deterioration has occurred, check with your dealer for the steps required to restore the finish. Buffing may be necessary in extreme cases.

Wax fiberglass surfaces at least once a year with a standard liquid or paste wax. Make sure to follow the directions for use as outlined by the product manufacturer. Make sure to wash and wax your unit out of the hot sun when exterior surfaces are cool. Storage of the motor home out of direct sun is also a primary way to help preserve fiberglass finishes.

Physical damage to fiberglass should be taken care of immediately to avoid moisture from entering through breaks and causing problems with interior walls and components. Cover breaks in the fiberglass with plastic, sealing the edges with tape until proper repairs can be made.

 **Note:** **DO NOT** use rubbing compound or any abrasive cleaner or cloth on the motor home. If using a tar and insect remover, make sure it is safe for use on painted surfaces and striping decals.

 **Note:** The exterior painted finish on the motor home is of the finest quality. Proper maintenance will assure a long lasting durable finish. **Do not wax or polish the exterior for the first 60 days.**

EXTERIOR PAINT (OPTIONAL)

Pressure Washing

Extreme caution should be used when using a pressure washer to wash the motor home, as severe damage to the paint could result. The tip of the pressure washer should never be adjusted to a "pin point" type spray. A fan type spray which disburse the water over a larger area should be used. Also, if the pressure is adjustable, set it to the lowest setting. The spray tip should remain a minimum of 30" away from the surface of the motor home to ensure safe cleaning.

 **Note:** If using a tar and/or insect remover, insure it is safe for painted surfaces and decals.

Precautionary Measures

- Avoid parking under trees or near ocean salt spray.
- Ice or snow should not be scraped from the painted surface. Brush off.
- If the vehicle sets more than 24 hours, remove any front protective covering (bra) while not being driven.
- Commercial washes should be avoided. Wash with cold water using a mild liquid soap. Dry wiping with a dry cloth is not recommended.
- When driving, avoid gravel roads.
- Anti-freeze, gasoline, or window solvent spilled on painted surfaces should be rinsed off with water immediately.
- Rinse off bugs and bird droppings daily with water.

Any exterior finish will deteriorate with time. Dulling and fading can be increased by prolonged exposure to extreme sunlight, air pollutants, and excessive moisture. Surface weathering of fiberglass will not diminish structural integrity. Regular monthly washing and polishing of exterior surfaces is the best insurance against surface deterioration such as fading, yellowing, or chalking. Take care to avoid spraying water directly into refrigerator and furnace vents when washing the motor home.

If surface deterioration is apparent, contact a Four Winds International dealer for assistance with finish restoration. Physical damage to the fiberglass, such as cracks, holes, and chips, must be attended to immediately to avoid moisture from entering and causing problems with interior walls and components. Cover these areas with plastic, sealing the edges with tape until proper repairs can be made.

SEALS AND ADHESIVES

Failure to maintain seals through regular maintenance can lead to damage of motor home components, and may be considered abusive treatment under terms of your motor home warranty.

It is important to maintain the seals and adhesives of your motor home to prevent moisture from entering and destroying motor home components. When washing your motor home, inspect the seals for signs of drying out and wear. Be aware that weather, sun, and road vibration will have an effect on seals, causing them to dry, crack, or separate. If you are unsure what to look for, have your dealer instruct you, and also show you the correct method for renewing the seals. All exterior seals should be checked and resealed as needed at least every six months.

 **Note:** It is especially important to check the seals before and after periods of extended storage or non-use. Fall and spring inspections are recommended.

 **Note:** Be aware that moisture can accumulate in locks and hinges of windows and doors, causing damage or faulty operation. Do not force the operation of these components in sub-freezing weather.

FRAME

Check the condition of the frame regularly. Keep it clean, and repaint as necessary to help avoid rust. It is especially important to keep under-body components clean, when driving the motor home in the winter in areas where road salts are used.

WHEELS

To keep the rims of the motor home looking their best, follow these simple steps:

1. Rinse the wheel with high-pressure water to remove any debris, grit or dirt particles.
2. Use a 100% cotton cloth dipped in a mild soap solution to help remove stuck on dirt and grease.
3. Rinse the remaining soap residue from the wheel.
4. Dry the wheel thoroughly with a 100% cotton cloth.



Note: In areas where hot sun constantly beats down on the motor home, shading the tires or covering can reduce tire sidewall cracks from forming.

ROOF

Inspection of roof components at least twice a year is very important to make sure seals are not cracked or worn. Proper maintenance of seals is necessary to keep moisture from entering and causing severe damage such as rot, mold, or mildew. If you encounter drying, cracked, or weathered seals, make sure to reseal as necessary. Check with your dealer for the type of caulking required for roofs and correct methods of resealing. Special sealers are also required for the skylights.

It is especially important to check the seals before and after periods of extended storage or non-use. Fall and spring inspections are recommended. Four Winds International recommends all roof maintenance be performed by your dealer.



Note: If your roof should somehow be punctured, cover the puncture to seal out moisture, and have it repaired as soon as possible (check with your dealer).

EXTRUSIONS AND ALUMINUM SURFACES

Clean and wax all extrusions when waxing motor home sidewalls, to help avoid surface pitting. Special aluminum cleaners are available to restore the original luster to aluminum surfaces. Make sure to follow the instructions for use as outlined on the product package.

Chrome surfaces can be restored with special chrome polish if regular cleaning methods are not successful. Again, make sure to follow product instructions for use.

WINDOWS AND DOORS

Check the seals around the windows at regular intervals. Follow previous instructions for checking the condition of seals and repairing as necessary.

Make sure that windows remain operative by adjusting and lubricating latches and moving parts annually. Also check the condition and operation of the door locks, adjusting and lubricating as necessary. Use powdered graphite or light oil to lubricate moving parts on doors and windows.

Vinyl seals around windows and doors should be cleaned regularly, and kept supple by use of a silicone spray (make sure to follow the directions on the product).

Keep screens and window slides clean and free of debris, to maintain proper operation, and avoid component road damage. Test the operation of all windows occasionally to make sure they are working properly, including closing flush and locks holding tight.

Check with your dealer if you are unsure about the correct methods of lubrication and adjustment.

 **Note:** Be aware that moisture can accumulate in locks and hinges of windows and doors, causing damage or faulty operation. Do not force the operation of these components in sub-freezing weather.

PROPANE GAS SYSTEM

The Propane Gas system should be checked regularly for leaks and damage. Follow the lines, looking for kinks or flattened spots that could have occurred during travel or maintenance on the motor home. The entire system, including regulator pressure, should be checked annually, or whenever you suspect a problem, by a qualified Propane Gas service technician using proper equipment. The method of checking the system for leaks, and Propane Gas safety precautions can be found elsewhere in this manual.

 **Note:** Line pressure for Propane Gas appliances should be checked at least every six months. Most Propane Gas suppliers have equipment to make the test for you. The correct line pressure for all of the Propane Gas appliances is 11" of water column pressure.

DRAINAGE SYSTEM

The drainage system, including the tanks and associated drain piping should be periodically inspected for road damage. Any deterioration of the sealant around joints and fittings should be repaired immediately.

Check the operation of the termination valves. If they pull or close with effort, lubricate the shaft and slide valve with spray silicone. Termination valves that leak should be repaired or replaced as soon as possible.

Sometimes, a buildup of paper or other material in the inside groove of the termination valve can obstruct the valve and cause it to seat improperly. If you suspect that this is occurring, the valve can be removed from the drainage line by removing the four screws that hold it in place and sliding it out. The valve groove may then be cleaned out with a screwdriver or similar tool. Replace the valve in the line and reinstall the screws to secure it in place.

TV ANTENNA

To lubricate the elevating gear, apply a liberal amount of silicone spray lubricant to the elevating gear with the lift in the down position. Run the lift up and down a few times to distribute the lubricant over the gears.

If rotating the antenna becomes difficult, normal operation can be restored by lubricating the bearing surface between the rotating gear housing and the base plate. Any spray type silicone lubricant may be used.

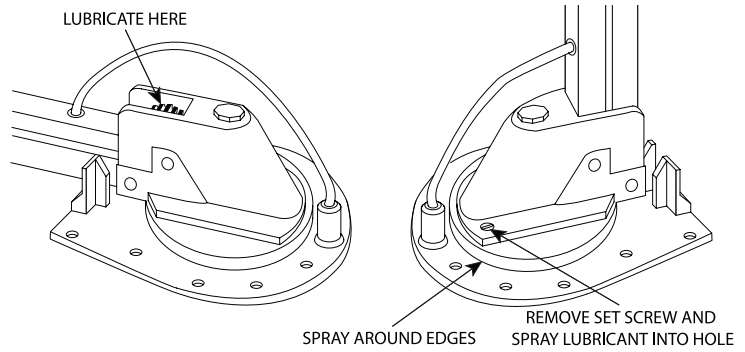

Elevate the antenna and remove the set screw from the rotating gear housing (see illustration). Spray lubricant into hole and around the edges of the gear housing. Rotate the gear housing until the lubricant coats the bearing surfaces and the antenna rotates freely.

EXTERIOR LIGHTS

Make sure to check the operation of all exterior lights often. Check identification, clearance, turn signal, brake, and backup lights to make sure they are working correctly. Replace burnt out bulbs as soon as possible.

Head lamp Condensation

Condensation occurs when the air inside the lamp assembly, through atmospheric changes, reaches the “dew point”. When this takes place, the moisture in the air within the lamp assembly condenses, creating a fine mist or white fog on the inside surface of the lamp lens or chrome reflector surfaces. The head lamps are designed to remove accumulated moisture vapor by expelling it through a vent system as the light warms up. The vent system operates at all times, however it is most effective when the lamps are on and the vehicle is in motion. Since most motor homes are parked for long periods of time, they have a greater chance of condensation build-up.

 **Note:** Check head lamp regularly for condensed water drops (daily in high humidity areas).

If small drops of condensed water are noted, drive the motor home with head lamps “ON” or just turn “ON” the head lamps. This will evaporate the condensed water drops and will avoid water being accumulated. Depending on the size, shape and location of the lamp on the motor home, and the atmospheric conditions occurring, the amount of time required to clear the lamp may vary.

Check the head lamp vent tubes, this will be a small rubber hose or plastic cap located on the back of the light, make sure that they are free of dirt and the rubber is not cracked or dried out. If the vent tubes are clogged, cracked or dried out the vent system will not work correctly, allowing condensation to build up in the lamp. If the tube is cracked or dried out please replace it, replacement parts can be acquired from your motor home Dealer.

Head lamp Maintenance

Cleaning is the most effective maintenance that you can perform on your lights, dirt and road grime build up can cut light output by 40% or more.

When cleaning your head lamps, please observe the following: do not rub them dry, and never use abrasives or strong solvents. Remove dirt and contamination, such as insects, by soaking with shampoo and then rinsing with plenty of water. Always use a de-icer spray to remove accumulated ice and snow; never use a scraper.

Head lamp seals should not be directly sprayed with high pressure (home or industrial) wash systems. Damage to the seal can occur, causing the housing to leak water.

Chemicals: Composite head lamps have a polycarbonate lens, which is very sensitive to a variety of chemicals. Contact with certain chemicals can cause crazing, softening or cracking of the lens, which would require replacement of the entire lamp housing. The following chemicals are suspected to cause similar results. Mild soap and water is recommended for the cleaning of your lamps.

DO NOT USE THE FOLLOWING TO CLEAN THE HEAD LAMP LENS:

Acetone	Gasoline	Oils
Agitene®	Kleenol Plastics	Pink Lux® (phosphate free)
Benzyl	Lemon Joy® (phosphate free)	Stanisol Naphtha®
Carbon Tetrachloride	Lestoil®	Texiz-8006, 8129, 8757
Chlorinated	Liquid Cleaner - 8211	Toluol
Citrus Orange Cleaners	Liquid Detergents	Tricholor
Corrosive or Caustic Cleaners	Lysol®	Triclene®
Diversol®	Methyl Ethyl	Keyton (MEK)

Head lamp Bulb Replacement

 **Note:** Damage to the lamp assembly by these chemicals is not covered under the manufacturer's warranty.

TO PREVENT INJURIES AND DAMAGE, COMPLY WITH ANY INSTRUCTIONS PROVIDED BY THE BULB MANUFACTURER.

Whenever working on any electrical system, switch off the electrical accessory you are working on or refer to the electrical system section of your owner's manual. Failure to do this could result in short circuits.

NOTICE

When replacing the halogen bulb do not touch the glass portion of the bulb with your bare hands since even small amounts of impurities burn into the surface and reduce the service life of the bulb. Use a clean cloth, paper napkin, or similar material to hold the bulb during installation. With most bulbs you will not need to touch the glass part to install the bulb.

SINKS AND COUNTER TOPS

Clean with hot soapy water or a good liquid cleaner. Avoid using abrasive cleaners. Never use steel wool on stainless steel, since the steel particles left in the sink can rust and become unsightly. Also, when cleaning stainless steel with a mild cleanser, rub gently with the grain, and rinse well. Rinse after each use and wipe dry.

APPLIANCES

Make sure to read all literature provided with each of the appliances, and follow the maintenance instructions included. Pay particular attention to any cautions or warnings included. Each appliance in the motor home is warranted by their respective manufacturer.

Propane Gas Appliances And Equipment

Follow the instructions and warning noted in the appliance and equipment owner's manual as well as the ones listed below:

- Annual maintenance should be conducted on the Propane Gas appliances and equipment by an authorized dealer or repair facility.
- Insects can build nests in the burners of the various appliances and equipment. The burner and burner orifice of the Propane Gas appliances and equipment should be cleaned out by an authorized dealer or repair facility anytime circumstances or conditions warrant, but no less frequently than on an annual basis.

PRE-FINISHED PANELS AND WOOD SURFACES

Treat cabinetry and wood surfaces as you would any fine furniture product in your home. Proper care and maintenance of wood products will keep them looking like new for many seasons of use.

Clean pre-finished panels with a spray-type furniture polish. Avoid getting wood surfaces wet. Wipe off and dry immediately if this occurs. Do not use abrasive cleansers around wood finishes. Clean regularly with a soft cloth and cleaner designed for wood products such as lemon oil or any oil based wood cleaning product. Avoid constant exposure to direct sunlight which can cause fading and drying of wood surfaces.

WATER SYSTEM

Check all hoses, fittings, and connections regularly for leaks and signs of wear. Make sure to keep the system sanitized, and take care to winterize during cold weather (see instructions elsewhere in this manual). Do not allow water to remain in system for extended periods or after a trip.

ELECTRICAL SYSTEM

The electrical system requires minimal maintenance under normal circumstances. Most electrical maintenance in the motor home involves the chassis and auxiliary batteries. Keeping the batteries properly maintained will help to eliminate many frustrating electrical problems. Make sure to refer to the index for the location of electrical and battery maintenance elsewhere in this manual.

The generator is another area in which simple preventive maintenance can "head off" problems before they happen. Read the manual supplied with the generator for the care and maintenance required on a regular basis. If you experience electrical problems with your motor home, make sure to have it checked by a qualified electrician.

ROOF VENTS

Check roof vents regularly for debris that may block air flow or jam the cranking mechanism. Lubricate the cranking.

ABS PLASTIC

NOTICE

AVOID ABRASIVE CLEANSERS (even the liquid and cream types), alcohol based products, and solvents such as acetone and MEK. Gasoline and kerosene should not be used because of the damaging effect they have on the plastic surface, as well as the fire hazard they present. Often the damage caused by solvents, alcohol, citrus based and oil based products may not be immediately noticeable, but the plastic is made weaker, and prone to stress cracking.

Many components of the motor home are constructed of strong, lightweight ABS plastic. Sometimes, it may be necessary to remove stains, or generally clean. A mild solution of soap and water will clean many stains, and should be used initially. Tougher stains may require stronger cleaners, but be sure to read the label to determine if the product is recommended for use on plastics.

WINTER PRECAUTIONS

Water System

If the fresh water storage tank is located inside the coach, the normal heating of the coach during moderately cold weather should be enough to insure its not freezing. In severe cold however, it is wise to monitor the water temperature in the tank, and take appropriate steps to drain and winterize if necessary. In severe cold it may be necessary to open lower cabinet doors at night in both the bath and kitchen areas to keep warmer air circulating around water fixtures.

If you are going to have to leave the coach unheated for any length of time in severe cold conditions, it is best not to keep water in the fresh water tank. It may work best to carry cooking and drinking water with you in plastic jugs instead.

If you will be using your motor home when conditions fall below the freezing level, it will be necessary to protect the drainage system components from damage by the addition of an approved antifreeze solution as outlined on the product directions. Drain lines which are exposed outside the motor home are especially susceptible to freezing, and steps should be taken to protect them from damage.

Food Storage

In the event the motor home is left for a period of time without the furnace in operation, canned goods and other foods packed in water should be stored as high as possible, since heat rises. They might also be stored in the refrigerator as insulation against the cold. Store dry foods, and other items that are not damaged by freezing in the lower storage areas.

Propane Gas System

Make sure to use a Propane Gas that will vaporize properly in the colder temperatures. Check with your Propane Gas representative for the proper fuel, and read the information on Propane selection in the Propane Gas section of this manual (check the Index for the location).

 **Note:** It is important to remember that heating with Propane consumes gas rapidly, so refill tank immediately when low, to avoid running out completely.

Heating

⚠ DANGER NEVER USE THE RANGE FOR HEATING. ASPHYXIATION COULD RESULT. Use ONLY the furnace to heat the motor home. It is properly vented to the outside.

STORAGE PREPARATION

When storing the motor home for the winter (or other extreme conditions), certain precautions need to be made to protect it until you open it again for use. Make sure to talk with your local dealer concerning any special requirements for storage in your particular geographic area. The following steps are general, and your dealer can help you choose those that are most appropriate for your needs.

1. Make sure to park the motor home on a level surface.
2. Make sure to winterize the chassis as outlined in the chassis owner's manual, and also the 120V generator (If so equipped) as outlined in the generator owner's manual.
3. Clean the motor home thoroughly, both inside and out, as previously outlined including the refrigerator.
4. Make sure all electrical switches and appliances are turned off.
5. Close all the drapes and curtains, and protect the curtains from sun fading by placing foil, or paper between the windows and the screens.
6. Make sure all windows, doors, and vents are closed securely. Cover exterior vents on appliances to prevent moisture and insects from entering during storage.
7. Check the interior of the motor home periodically while in storage to make sure leaks have not developed, or condensation formed that can cause damage to interior components. Condensation can most readily be observed as moisture accumulation on windows and mirrors. To reduce condensation, make sure to air the motor home out occasionally during storage.
8. Be sure that both the chassis and auxiliary batteries have the proper electrolyte level and that they are fully charged (12.7 Volts). A discharged battery will freeze and crack the case, ruining the battery. In storage, a battery will lose charge gradually over a 30 to 45 day period, even when disconnected by use of the battery disconnect switch. We recommend that at least monthly the batteries be checked for charge. If the charge is 80% (12.5 Volts) or less, it must be recharged.
 - You may wish to remove the batteries from the motor home and store them in a heated area. However, even when warm, the battery charge level must still be maintained, a warm battery accepts charge much more readily however, than a cold one.
 - Make sure to follow all precautions associated with battery care and maintenance outlined in the electrical section of this manual.
9. Store with as much fuel as possible in the fuel tank to limit condensation buildup.
10. Check engine coolant, making sure antifreeze is sufficient for local temperature extremes.
11. Make sure the tires are inflated to correct pressures.
12. Store the windshield wiper arms and blades inside the motor home.
13. Let the engine run for a period of time until it is warm. Change the oil and oil filter.
14. Run the air conditioner during this final engine warm up to make sure the compressor seal is lubricated.
15. If snow accumulates on the motor home, try to remove it as often as you can.
16. A primary concern when winterizing the motor home is to make sure the water systems are protected against damage caused by freezing. Follow the water system winterizing procedure outlined in the Water and Drainage section of this manual (check the Index for location).



Note: Be sure to read the rest of this manual, and follow any additional information on storage, cleaning, and winterizing procedures.

MOLD

Molds are microscopic organisms that naturally occur in virtually every environment, indoors and out. Outdoors, mold growth is important in the decomposition of plants. Indoors, mold growth is unfavorable. Left unchecked, molds break down natural materials, such as wood products and fabric. Knowing the potential risks is important for an owner to protect their investment.

According to the Center for Disease Control, exposure to damp and moldy environments may cause a variety of health effects, or none at all. Some people are sensitive to molds. For these people, molds can cause nasal stuffiness, throat irritation, coughing or wheezing, eye irritation, or, in some cases, skin irritation. People with mold allergies may have more severe reactions. Immune-compromised people and those with chronic lung illnesses, such as obstructive lung disease, may get serious infections in their lungs when they are exposed to mold.

Factors Contributing to Mold Growth

For mold growth to occur, temperatures, indoor or outdoors, must be between 40 degrees and 100 degrees Fahrenheit and also have a source of moisture, such as humidity, standing water, damp materials, etc. Indoors, the most rapid growth occurs with warm and humid conditions.

Inhibiting Mold Growth

By controlling relative humidity, the growth of mold and mildew can be inhibited. In warm climates, use of the air conditioner will reduce the relative humidity. Vents are located in the bathing and cooking areas and constant use is advised during food preparation and bathing, even during colder weather. Additionally, opening a window during these activities will assist in ventilation. In extremely humid conditions, the use of a dehumidifier can be helpful.

 **Note:** If using a dehumidifier, please read and follow all manufacturer instructions and recommendations to the use and cleaning of the dehumidifier.

Ideally, relative humidity should be at 60% or less. Relative humidity can be monitored utilizing a portable hygrometer, a small device that measures temperature and relative humidity. Hygrometer's are available at electronics or building supply stores for minimal cost.

 **Note:** In cold climates, relative humidity may need to be at 35% or less to avoid window condensation.

Frequent use of the motor home or cleaning regularly is an important preventive measure. Further, any spills should be wiped up quickly and dried as soon as possible. Avoid leaving damp items lying about. On safe surfaces, use mold or mildew killing cleaning products. Check sealants regularly, and reseal when necessary to avoid water leaks. Proper preventive maintenance to the motor home and its accessories, as described both in this manual and in accompanying

Effects of Prolonged Occupancy

Your motor home was designed primarily for recreational use and short-term occupancy. If you expect to occupy the motor home for an extended period, be prepared to deal with condensation and the humid conditions that may be encountered. The relatively small volume and tight compact construction of modern motor homes mean that the normal living activities of even a few occupants will lead to rapid moisture saturation of the air contained in the motor home and the appearance of visible moisture, especially in cold weather.

Moisture can condense on the inside surfaces of the motor home during cold weather when relative humidity of the interior air is high. Insulated walls of a motor home are much thinner than house walls. Estimates indicate that a family of four can vaporize up to three gallons of water daily through breathing, cooking, bathing, and washing. Unless the water vapor is carried outside by ventilation, or condensed by a dehumidifier, it will condense on the inside of the windows and walls as moisture, or in cold weather as frost or ice. It may also condense out of sight within the walls or the ceiling where it will manifest itself as warped or stained panels. Appearance of these conditions away indicate a serious condensation problem. When you recognize the signs of excessive moisture and condensation in the motor home, action should be taken to minimize their effects.

 **Note:** Your motor home is not designed, nor intended, for permanent housing. Use of this product for long term or permanent occupancy may lead to premature deterioration. Long-term occupancy may not be considered normal, and may under the terms of the warranty constitute misuse, abuse or neglect, and void certain warranty protections.

Tips to Controlling Condensation

To avoid condensation problems, try to follow these tips to help alleviate excess moisture:

- Allow excess moisture to escape to the outside when bathing, washing dishes, hair drying, laundering, and using appliances and non-vented gas burners.
- Always use the vent hood when cooking.
- Keep the bathroom door closed and the vent or window open when bathing and for a period of time after you have finished.
- Do not hang wet clothes in the vehicle to dry.
- In hot weather, start the air conditioner early as it removes excess humidity from the air while lowering the temperature.
- Keep the temperature as reasonably cool during cold weather as possible. The warmer the vehicle, the more cold exterior temperatures and warm interior temperatures will collide on wall surfaces, thus creating condensation.
- Use a fan to keep air circulation inside the vehicle so condensation and mildew cannot form in dead air spaces. Allow air to circulate inside closets and cabinets (leave doors partially open). Please keep in mind that a closed cabinet full of stored goods prevents circulation and allow the exterior temperature to cause condensation.
- The natural tendency would be to close the vehicle tightly during cold weather. This will actually compound the problem. Simply put, you need to remove some of the warm air, and allow some cool outside air to get inside the vehicle, so the furnace will not recycle the humid interior air.
- Use fluorescent ceiling lights and minimize prolonged use of incandescent lights, which produce heat and contribute to condensation in the roof above the ceiling lights.

Avoid Drastic Thermostat Setbacks

Cooler surface temperatures increase the potential for condensation and surface mold growth. To minimize the opportunity for condensation to form on interior surfaces, maintain a comfortable temperature in the motor home, and avoid nighttime setbacks of 10° or more. Drastic setbacks that reduce the indoor air temperature quickly can increase the chance for airborne moisture to condense on cool surfaces such as windows. If you are away from the motor home for an extended number of days, we recommend that you do not set the temperature back without taking other measures to manage relative humidity, including operating a dehumidifier with a continuous drain.

Carpet Care And Moisture Management

The carpet should be cleaned when it shows signs of discoloration or traffic patterns. The use of a professional steam cleaning system is recommended for cleaning the carpet, unless otherwise noted. To manage moisture from the cleaning process, the cleaning system needs to be capable of extracting the excess water from the carpet after it has been cleaned. Important: Be sure the carpet is thoroughly dry before closing the motor home for storage. Water from the cleaning process can cause significant damage to the motor home if the carpet is not completely dry before closing up the motor home for an extended period.

Exterior Care of the Motor Home

The exterior shell of the motor home is the primary weather and moisture barrier. Over the life of the motor home, the shell will require regular care and maintenance. The shell includes the roof, sidewalls, windows, doors and under carriage of the motor home. Particular attention needs to be devoted to ensure these components are maintained to ensure a tight barrier against bulk water intrusion.

The shell should be inspected periodically for tears, gaps, and condition of sealants. Areas that require maintenance should be resealed utilizing a proven, high quality sealant of similar characteristics as the original sealant.

Particular attention should be devoted to ensure the slide outs are functioning properly. Each time a slide out is used, it should be inspected to ensure proper operation and sealing. The slide out gaskets should also be inspected to ensure proper sealing when the slide out is operated.

Storage of the Motor Home

During those periods when the motor home is not in use, care must be taken to ensure moisture sources are addressed. Ideal storage of the motor home would be in an enclosed climate controlled environment. When this is not possible, the following steps should be taken to ensure moisture is controlled:

- Turn off all water sources.
- Turn off all combustion appliances.
- Drain all holding tanks.
- Drain the water heater.
- Open all closets, cabinet doors and drawers.
- Close all windows and entrance doors.
- Open a vent enough to allow for some limited ventilation air flow, but not so far as to allow snow or rain to enter.
- When storing the motor home high humidity climates (ambient relative humidity is greater than 60% year round), add a dehumidifier drained to the exterior to control humidity inside the recreational vehicle during storage.

Areas that are exposed to water spills or leaks should be dried as soon as possible and definitely within 24-48 hours. Drying areas quickly minimizes the chance for moisture damage and possible mold growth, which can begin to form colonies in 48 hours. A variety of methods can be used to help the drying process:

- Remove excess water with an extraction vacuum.
- Use a dehumidifier to air drying.
- Use portable fans to move air across the surface.
- Because moisture is key to mold issues, treat all signs of condensation and spills seriously and deal with promptly. Failure to deal with a moisture issue promptly may cause more severe issues where none initially existed, or may make a small problem much worse.
- Learn to recognize signs of mold - don't paint over or cover up suspicious discoloration until you are sure it is not mold. The affected surface must first be cleaned and dried; residual staining may be painted.
- Be sure to understand and eliminate the source of moisture accumulation as a part of the clean-up.
- Small amounts of mold should be cleaned as soon as it appears. Small areas of mold should be cleaned using a detergent/soapy solution or an appropriate household cleaner. Gloves should be worn during cleaning. The cleaned area should then be thoroughly dried. Dispose of any sponges or rags used to clean mold.

PERIODIC MAINTENANCE CHART

For your convenience, a Maintenance Chart is presented below. For detailed information regarding specific product service and maintenance procedures, refer to the products respective owner's manual.

 **Note:** The following chart is a guide only. Service and maintenance intervals may vary depending on product performance, usage, and/or environmental conditions.

ITEM							PROCEDURE
	EACH TRIP	MONTHLY	EVERY 3 MONTHS	EVERY 6 MONTHS	YEARLY	AS REQUIRED	
Fiberglass Exterior	▲						Wash with Warm Water & Mild Detergent
				▲			Wax with Liquid or Paste Wax
Roof & Roof Components				▲			Inspect & Reseal as Needed
					▲		Lubricate Roof Vent Mechanism with Light Oil & Clean
					▲		Lubricate Roof Antenna with Silicone Lubricant Spray
Windows & Doors	▲						Check Vinyl Seals when Washing Exterior
		▲					Check Seals for Damage & Repair as Needed
		▲					Lubricate Door Hinges & Step Components
					▲		Adjust & Lube Window Latches
					▲		Lubricate Door Locks & Strike Pocket, Include Exterior Storage Doors
Seals & Adhesives	▲						Inspect & Reseal as Needed
LP Gas System					▲		Check for Leaks & Road Damage
					▲		Qualified Service Technician Inspection
Water Drainage		▲					Check Hoses, Fittings & Connections for Leaks & Signs of Wear
	▲						Check Drainage System for Leaks & Road Damage
					▲		Sanitize Fresh Water System
					▲		Winterize System Depending on Local Seasonal Conditions
Electrical System		▲					Check GFCI Circuits
					▲		Generator Maintenance as Outlined in Generator Manual
		▲					Check & Service Batteries
Appliances	▲						Remove Food & Ice from Refrigerator
		▲					Clean Fan Blades & Wash Filter on Range Exhaust Hood
		▲					Check for Obstructions & Dirt on Exterior Appliance Vents
Safety Equipment					▲		Clean CO, Smoke & LP Detectors
	▲						Test All Detectors
		▲					Check Fire Extinguisher Pressure & Condition
Carpeting	▲						Vacuum
					▲		Clean
Wood Surfaces		▲					Clean Pre-Finished Panels & Wood
Seats					▲		Lubricate all Mechanisms & Inspect for Proper Operation
					▲		Check all Seat Belt Buckles, Release Mechanisms & Belt Webbing
Chassis Components					▲		Follow Chassis Lubrication & Maintenance Procedures & Schedules
Weight & Distribution	▲						Properly Load and Verify Specified Load Limits & Weight Distribution

INDEX

12 VOLT SYSTEM FUSES - DIESEL	71
Bed Base Fuse Panel	71
Inverter Bay Fuse Panel	71
12 VOLT SYSTEM FUSES - GAS	69
Automotive	69
Interior	69
A	
ABS PLASTIC	94
ACKNOWLEDGEMENT OF RECEIPT OF WARRANTY	7
APPLIANCES	93
Propane Gas Appliances And Equipment	94
AUTOMATIC HYDRAULIC POWER LEVELERS	43
Automatic Leveling And Retraction Procedure	44
Emergency Retraction Procedure	45
Hydraulic Pump Function Wiring	45
AWNINGS	56
Automatic Patio Awning	57
Extend the Awning	57
Manually Closing The Automatic Awning	57
Manual Patio Awning	57
Retract the Awning	57
Slide Out Awning	56
B	
BATTERIES	64
Battery Charging	66
Battery Disconnect Switch	66
Battery Isolator Controller	65
Battery Maintenance	65
Battery Safety	64
C	
CARBON MONOXIDE AND SMOKE DETECTORS	19
Carbon Monoxide Safety Precautions	20
Regular Maintenance	20
Testing Procedure	20
CEILING VENTS	61
Attic Fan - Create A Breeze	62
Attic Fan - Fantastic Vent	62
Exhaust Vent	61
CHASSIS ALTERNATOR	72
CHEMICAL SENSITIVITY	23
Formaldehyde	23
Ventilation	23
CIRCUIT BREAKERS	69
CLASS A AND CLASS C - GAS SYSTEM PANELS	70
110 V For Units With 30 Amp Service And No Electric Water Heater	70
110V For Units With 50 Amp Service	70
BCC Fuse Panel	71
Converter Fuse Panel	70

D

DASH CONTROLS - GAS	30
Emergency Start	30
Fog Lights	30
Generator Remote Start	30
Mirror Control Button	30
Mirror Heat	30
Windshield Fans	31
DASH CONTROLS AND INSTRUMENT PANELS - DIESEL	31
Freightliner Only Information Message Center	32
Keypad Push Button Shift Selector	32
Transmission Control Push Button Shift Selector	31
DASH FUSES	72
DASH PANEL HEATER AND AIR CONDITIONER	59
Control Panel	59
Operating Features	59
Warranty/Service	60
DASH PANEL SWITCHES	34
Battery Boost	35
Block Heat	34
Docking Lights	34
Light Control Knob	35
Panel Light Dimmer Control Wheel	35
DASH RADIO	39
DOORS, DRAWERS AND STORAGE COMPARTMENTS	50
Bed Storage (Some Models)	50
DRAINAGE SYSTEM	91

E

ECLIPSE GPS NAVIGATION SYSTEM OPTION DIESEL	41
EGRESS WINDOW	25
ELECTRICAL SYSTEM	94
ELEVATED BEDS AND ELECTRIC BED LIFT SYSTEMS	51
Tips for Safe Usage	52
ENTRY DOOR	55
ENTRY STEP	55
EXTERIOR LIGHTS	92
Head lamp Bulb Replacement	93
Head lamp Condensation	92
Head lamp Maintenance	92
EXTERIOR PAINT (OPTIONAL)	89
Precautionary Measures	89
Pressure Washing	89
EXTRUSIONS AND ALUMINUM SURFACES	90

F

FIBERGLASS SIDING	88
FIRE EXTINGUISHER	19
FIRE SAFETY	18
FOUR WINDS LIMITED WARRANTY	4
FRAME	90
FRESH WATER SYSTEM	74
External Hook-up	74
Fresh Water Tank With Gravity Fill	74
Fresh Water Tank Without Gravity Fill	75
Sanitizing the Fresh Water System	76
Water Pump	75
FURNACE	61
Furnace Operation Instructions	61
FURNITURE	52
Air Hide A Bed (No Drawer Storage Below)	53
Air Hide A Bed Sofa (Drawer Storage Below)	53
Barrel Chair	53
Dinette	54
Euro Recline With Ottoman	54
Hide -A- Bed Sofa	53
Jack Knife Sofa	52
Lounge Table	54
Pilot And Co-Pilot Seats	54
Space Saver Sofa	53

G

GARAGE AREA (AVAILABLE ON SELECT MODELS)	58
Fold-Down Ramp	58
Reduce The Risk Of Fire, Explosion Or Asphyxiation	58
GENERATOR	73
GROUND FAULT CIRCUIT INTERRUPTER	68

K

KEYPAD KEYLESS ENTRY SYSTEM	42
3 Button Transmitter Programming	42
4 Button Transmitter Programming	42
Programming The Keyless Entry System Transmitter	42
Programming The Keypad Button Chirp On / Off	42
Programming The User Code	43

L

LAWS OF THE ROAD	16
-------------------------------	-----------

M

MANUFACTURERS WARRANTIES	12
MOLD	96
Avoid Drastic Thermostat Setbacks	98
Carpet Care And Moisture Management	98
Effects of Prolonged Occupancy	97
Exterior Care of the Motor Home	98
Factors Contributing to Mold Growth	97
Inhibiting Mold Growth	97
Storage of the Motor Home	99
Tips to Controlling Condensation	98
MONITOR PANEL	77
Inaccurate Holding Tank Level Readings	77
Over Sensitive Readings	77
Under Sensitive Readings	77
MOTOR HOME LOAD LIMITS	13
Occupant And Cargo Carrying Capacity	13
MOTOR HOME SERIAL NUMBER DECAL & DATA PLATES	17

P

PERIODIC MAINTENANCE CHART	100
POWER CONVERTER	67
POWER INVERTER - DIESEL	67
Remote Control	67
PRE-FINISHED PANELS AND WOOD SURFACES	94
PROPANE GAS DETECTOR	21
About the Propane Gas Detector	22
Checking the Propane System for Leaks	22
How To Test	21
Maintenance	21
Most Common Causes of Apparent Malfunction	22
PROPANE GAS HOSES PIPES TUBES AND FITTINGS	86
PROPANE GAS SAFETY PRECAUTIONS	87
PROPANE GAS SYSTEM	91
PROPANE GAS TANK	84
Filling the Tank	84
Propane Gas Regulator	85
Regulator Freeze-Up	85

R

REAR LADDER/ROOF ACCESS	56
REAR VISION SYSTEM	38
Camera Operation	39
REPORTING SAFETY DEFECTS	16
ROOF	90
ROOF MOUNTED AIR CONDITIONER	60
Performance Characteristics	60
Return Air Filters	60
ROOF VENTS	94

S

SAFETY REGULATIONS FOR PROPANE GAS SYSTEMS AND APPLIANCES	17
SEALS AND ADHESIVES	89
SEAT BELTS	23
Child Restraints	24
Maintenance	24
Seat Belt Operation	24
SHIFTER PANEL SWITCHES	33
Air Horn	33
Ceiling Light	36
Door Awning	36
Engine Brake	33
Main Awning	36
Mirror Control Button	33
Mirror Heat	33
Porch Light	35
Privacy Shade	34
Step Cover	35
Step Light	35
Sun Visor	33
Tag Dump (Tag Axle Only)	34
Windshield Fans	34
SHORE CORD	63
30 Amp Shore Power	63
50 Amp Shore Power	64
SINKS AND COUNTERTOPS	93
SLEEP NUMBER BED	50
Using the Firmness Control System™	51
SLIDE OUTS	46
Electric Slide Out	48
Electric Slide Out - Manual Room Retraction Procedure	49
Hose Color Identification	48
Hydraulic Slide Out	46
To Extend Slide Out	46, 49
To Retract Slide Out	47, 49
SMART STEERING WHEEL	37
SPOTLIGHT	38
Programming The Transmitter	38
STEERING WHEEL ADJUSTMENT	36
Telescope	36
Tilt 3.....	6
STORAGE COMPARTMENTS	56
STORAGE PREPARATION	96
SYMBOLS	11
SYSTEMS COMPARTMENT - DIESEL	83

T

THERMOSTATS	61
TOILETS	80
Aria Deluxe II	80
TECMA Toilet	81
TRAILER TOWING	25
TRAVEL PREPARATION	28
Chassis Checks	28
Exterior Checks	28
Operational Checks	28
Pre-Trip Checklist	29
Undercarriage Checks	28
TURN SIGNAL/LANE CHANGE/HIGH-LOW BEAM/HAZARDS LEVER	36
TV ANTENNA	92

V

VEHICLE WEIGHING PROCEDURES	14
How To Weigh Your Motor Home	14
Weight Terms	15
Where To Weigh Your Motor Home	14
VENDOR CONTACT INFORMATION	12

W

WASTE WATER SYSTEM	77
Emptying the Holding Tanks	79
Holding Tanks	78
WATER SYSTEM	94
WATER SYSTEM MAINTENANCE	82
WATER SYSTEM WINTERIZATION	81
Class A Water System Winterization	81
Class C Water System Winterization	82
WHEELS	90
WINDOWS	50
WINDOWS AND DOORS	91
WINTER PRECAUTIONS	95
Food Storage	95
Heating	95
Propane Gas System	95
Water System	95

Four Winds

INTERNATIONAL

P.O. Box 1486 Elkhart, Indiana 46515

www.FOURWINDS-RV.com

